

1.3 Covering Spaces

We come now to the second main topic of this chapter, covering spaces. We have in fact already encountered one example of a covering space in our calculation of $\pi_1(S^1)$. This was the map $\mathbb{R} \rightarrow S^1$ that we pictured as the projection of a helix onto a circle, with the helix lying above the circle, ‘covering’ it. A number of things we proved for this covering space are valid for all covering spaces, and this allows covering spaces to serve as a useful general tool for calculating fundamental groups. But the connection between the fundamental group and covering spaces runs much deeper than this, and in many ways they can be regarded as two viewpoints toward the same thing. This means that algebraic features of the fundamental group can often be translated into the geometric language of covering spaces. This is exemplified in one of the main results in this section, giving an exact correspondence between the various connected covering spaces of a given space X and subgroups of $\pi_1(X)$. This is strikingly reminiscent of Galois theory, with its correspondence between field extensions and subgroups of the Galois group.

Definition and Examples

Let us begin with the definition. A **covering space** of a space X is a space \tilde{X} together with a map $p: \tilde{X} \rightarrow X$ satisfying the following condition: There exists an open cover $\{U_\alpha\}$ of X such that for each α , $p^{-1}(U_\alpha)$ is a disjoint union of open sets in \tilde{X} , each of which is mapped by p homeomorphically onto U_α .

In the helix example one has $p: \mathbb{R} \rightarrow S^1$ given by $p(t) = (\cos 2\pi t, \sin 2\pi t)$, and the cover $\{U_\alpha\}$ can be taken to consist of any two open arcs whose union is S^1 . A related example is the helicoid surface $S \subset \mathbb{R}^3$ consisting of points of the form $(s \cos 2\pi t, s \sin 2\pi t, t)$ for $(s, t) \in (0, \infty) \times \mathbb{R}$. This projects onto $\mathbb{R}^2 - \{0\}$ via the map $(x, y, z) \mapsto (x, y)$, and this projection defines a covering space $p: S \rightarrow \mathbb{R}^2 - \{0\}$ since for each open disk U in $\mathbb{R}^2 - \{0\}$, $p^{-1}(U)$ consists of countably many disjoint open disks in S , each mapped homeomorphically onto U by p .

Another example is the map $p: S^1 \rightarrow S^1$, $p(z) = z^n$ where we view z as a complex number with $|z| = 1$ and n is any positive integer. The closest one can come to realizing this covering space as a linear projection in 3-space analogous to the projection of the helix is to draw a circle wrapping around a cylinder n times and intersecting itself in $n - 1$ points that one has to imagine are not really intersections. For an alternative picture without this defect, embed S^1 in the boundary torus of a solid torus $S^1 \times D^2$ so that it winds n times monotonically around the S^1 factor without self-intersections, like the strands of a circular cable, then restrict the projection $S^1 \times D^2 \rightarrow S^1 \times \{0\}$ to this embedded circle.

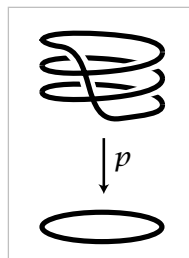

As our general theory will show, these examples for $n \geq 1$ together with the helix example exhaust all the connected covering spaces of S^1 . There are many other disconnected covering spaces of S^1 , such as n disjoint circles each mapped homeomorphically onto S^1 , but these disconnected covering spaces are just disjoint unions of connected ones. We will usually restrict our attention to connected covering spaces as these contain most of the interesting features of covering spaces.

For a covering space $p: \tilde{X} \rightarrow X$ the cardinality of the sets $p^{-1}(x)$ is locally constant over X , so if X is connected it is independent of x and called the number of **sheets** of the covering space. Thus the covering $S^1 \rightarrow S^1$, $z \mapsto z^n$, is n -sheeted and the covering $\mathbb{R} \rightarrow S^1$ is infinite-sheeted. This terminology arises from regarding the disjoint subspaces of $p^{-1}(U_\alpha)$ mapped homeomorphically to U_α in the definition of a covering space as the individual ‘sheets’ of the covering space. When X is disconnected the number of sheets can be different over different components of X , and can even be zero over some components since $p^{-1}(U_\alpha)$ is not required to be nonempty.

The covering spaces of $S^1 \vee S^1$ form a remarkably rich family illustrating most of the general theory very concretely, so let us look at a few of these covering spaces to get an idea of what is going on. To abbreviate notation, set $X = S^1 \vee S^1$. We view this as a graph with one vertex and two edges. We label the edges a and b and we choose orientations for a and b . Now let \tilde{X} be any other graph with four edges meeting at each vertex, and suppose the edges of \tilde{X} have been assigned labels a and b and orientations in such a way that the local picture near each vertex is the same as in X , so there is an a -edge oriented toward the vertex, an a -edge oriented away from the vertex, a b -edge oriented toward the vertex, and a b -edge oriented away from the vertex. To give a name to this structure, let us call \tilde{X} a *2-oriented graph*.

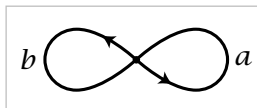

The table on the next page shows just a small sample of the infinite variety of possible examples.

Given a 2-oriented graph \tilde{X} we can construct a map $p: \tilde{X} \rightarrow X$ sending all vertices of \tilde{X} to the vertex of X and sending each edge of \tilde{X} to the edge of X with the same label by a map that is a homeomorphism on the interior of the edge and preserves orientation. It is clear that the covering space condition is satisfied for p . The converse is also true: Every covering space of X is a graph that inherits a 2-orientation from X .

As the reader will discover by experimentation, it seems that every graph having four edges incident at each vertex can be 2-oriented. This can be proved for finite graphs as follows. A very classical and easily shown fact is that every finite connected graph with an even number of edges incident at each vertex has an Eulerian circuit, a loop traversing each edge exactly once. If there are four edges at each vertex, then labeling the edges of an Eulerian circuit alternately a and b produces a labeling with two a and two b edges at each vertex. The union of the a edges is then a collection

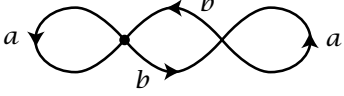
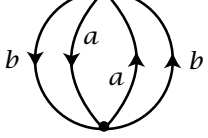
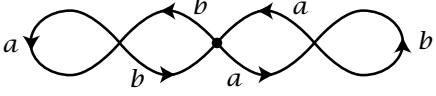
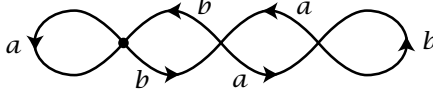
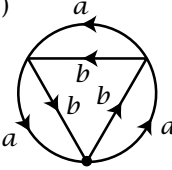
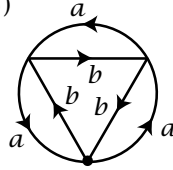
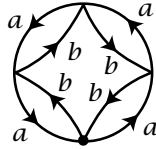
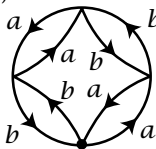
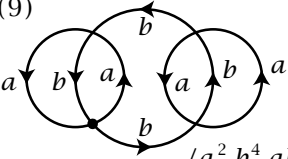
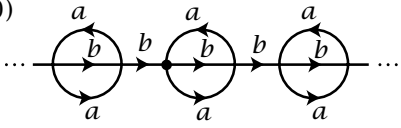
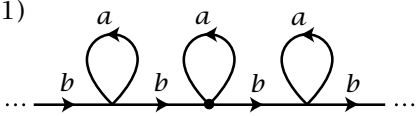
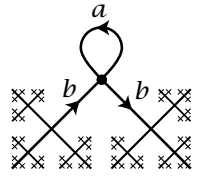
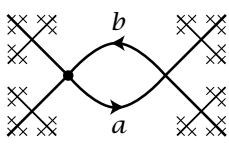
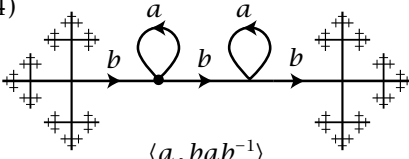
Some Covering Spaces of $S^1 \vee S^1$	
(1)  $\langle a, b^2, bab^{-1} \rangle$	(2)  $\langle a^2, b^2, ab \rangle$
(3)  $\langle a^2, b^2, aba^{-1}, bab^{-1} \rangle$	(4)  $\langle a, b^2, ba^2b^{-1}, baba^{-1}b^{-1} \rangle$
(5)  $\langle a^3, b^3, ab^{-1}, b^{-1}a \rangle$	(6)  $\langle a^3, b^3, ab, ba \rangle$
(7)  $\langle a^4, b^4, ab, ba, a^2b^2 \rangle$	(8)  $\langle a^2, b^2, (ab)^2, (ba)^2, ab^2a \rangle$
(9)  $\langle a^2, b^4, ab, ba^2b^{-1}, bab^{-2} \rangle$	(10)  $\langle b^{2n}ab^{-2n-1}, b^{2n+1}ab^{-2n} \mid n \in \mathbb{Z} \rangle$
(11)  $\langle b^nab^{-n} \mid n \in \mathbb{Z} \rangle$	(12)  $\langle a \rangle$
(13)  $\langle ab \rangle$	(14)  $\langle a, bab^{-1} \rangle$

of disjoint circles, as is the union of the b edges. Choosing orientations for all these circles gives a 2-orientation.

It is a theorem in graph theory that infinite graphs with four edges incident at each vertex can also be 2-oriented; see Chapter 13 of [König 1990] for a proof. There is also a generalization to n -oriented graphs, which are covering spaces of the wedge sum of n circles.

A simply-connected covering space of X can be constructed in the following way. Start with the open intervals $(-1, 1)$ in the coordinate axes of \mathbb{R}^2 . Next, for a fixed number λ , $0 < \lambda < 1/2$, for example $\lambda = 1/3$, adjoin four open segments of length 2λ , at distance λ from the ends of the previous segments and perpendicular to them, the new shorter segments being bisected by the older ones. For the third stage, add perpendicular open segments of length $2\lambda^2$ at distance λ^2 from the endpoints of all the previous segments and bisected by them. The process is now repeated indefinitely, at the n^{th} stage adding open segments of length $2\lambda^{n-1}$ at distance λ^{n-1} from all the previous endpoints. The union of all these open segments is a graph, with vertices the intersection points of horizontal and vertical segments, and edges the subsegments between adjacent vertices. We label all the horizontal edges a , oriented to the right, and all the vertical edges b , oriented upward.

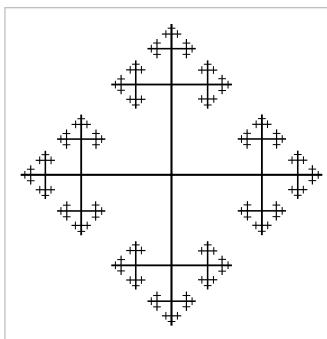

This covering space is called the *universal cover* of X because, as our general theory will show, it is a covering space of every other connected covering space of X .

The covering spaces (1)-(14) in the table are all nonsimply-connected. Their fundamental groups are free with bases represented by the loops specified by the listed words in a and b , starting at the basepoint \tilde{x}_0 indicated by the heavily shaded vertex. This can be proved in each case by applying van Kampen's theorem. One can also interpret the list of words as generators of the image subgroup $p_*(\pi_1(\tilde{X}, \tilde{x}_0))$ in $\pi_1(X, x_0) = \langle a, b \rangle$. A general fact we shall prove about covering spaces is that the induced map $p_* : \pi_1(\tilde{X}, \tilde{x}_0) \rightarrow \pi_1(X, x_0)$ is always injective. Thus we have the at-first-glance paradoxical fact that the free group on two generators can contain as a subgroup a free group on any finite number of generators, or even on a countably infinite set of generators as in examples (10) and (11). Another general fact we shall prove is that the index of the subgroup $p_*(\pi_1(\tilde{X}, \tilde{x}_0))$ in $\pi_1(X, x_0)$ is equal to the number of sheets of the covering space.

Changing the basepoint \tilde{x}_0 to another point in $p^{-1}(x_0)$ changes the subgroup $p_*(\pi_1(\tilde{X}, \tilde{x}_0))$ to a conjugate subgroup in $\pi_1(X, x_0)$, with the conjugating element of $\pi_1(X, x_0)$ represented by any loop that is the projection of a path in \tilde{X} joining one basepoint to the other. For example, the covering spaces (3) and (4) differ only in the choice of basepoints, and the corresponding subgroups of $\pi_1(X, x_0)$ differ by

conjugation by b .

The main classification theorem for covering spaces says that by associating the subgroup $p_*(\pi_1(\tilde{X}, \tilde{x}_0))$ to the covering space $p: \tilde{X} \rightarrow X$, we obtain a one-to-one correspondence between all the different connected covering spaces of X and the conjugacy classes of subgroups of $\pi_1(X, x_0)$. If one keeps track of the basepoint vertex $\tilde{x}_0 \in \tilde{X}$, then this is a one-to-one correspondence between covering spaces $p: (\tilde{X}, \tilde{x}_0) \rightarrow (X, x_0)$ and actual subgroups of $\pi_1(X, x_0)$, not just conjugacy classes. Of course, for these statements to make sense one has to have a precise notion of when two covering spaces are the same, or ‘isomorphic.’ In the case at hand, an isomorphism between covering spaces of X is just a graph isomorphism that preserves the labeling and orientations of edges. Thus the covering spaces in (3) and (4) are isomorphic, but not by an isomorphism preserving basepoints, so the two subgroups of $\pi_1(X, x_0)$ corresponding to these covering spaces are distinct but conjugate. On the other hand, the two covering spaces in (5) and (6) are not isomorphic, though the graphs are homeomorphic, so the corresponding subgroups of $\pi_1(X, x_0)$ are isomorphic but not conjugate.

Some of the covering spaces (1)–(14) are more symmetric than others, where by a ‘symmetry’ we mean an automorphism of the graph preserving the labeling and orientations. The most symmetric covering spaces are those having symmetries taking any one vertex onto any other. The examples (1), (2), (5)–(8), and (11) are the ones with this property. We shall see that a covering space of X has maximal symmetry exactly when the corresponding subgroup of $\pi_1(X, x_0)$ is a normal subgroup, and in this case the symmetries form a group isomorphic to the quotient group of $\pi_1(X, x_0)$ by the normal subgroup. Since every group generated by two elements is a quotient group of $\mathbb{Z} * \mathbb{Z}$, this implies that every two-generator group is the symmetry group of some covering space of X .

After this extended preview-by-examples let us return to general theory by defining a natural generalization of the symmetry group idea that we just encountered.

Group Actions

Given a group G and a space X , an **action** of G on X is a homomorphism ρ from G to the group $\text{Homeo}(X)$ of all homeomorphisms from X to itself. Thus to each $g \in G$ is associated a homeomorphism $\rho(g): X \rightarrow X$, which for notational simplicity we write as just $g: X \rightarrow X$. For ρ to be a homomorphism amounts to requiring that $(g_1 g_2)(x) = g_1(g_2(x))$ for all $g_1, g_2 \in G$ and $x \in X$, so the notation $g_1 g_2(x)$ is unambiguous. If ρ is injective then it identifies G with a subgroup of $\text{Homeo}(X)$, and in practice not much is lost in assuming ρ is an inclusion $G \hookrightarrow \text{Homeo}(X)$ since in any case the subgroup $\rho(G) \subset \text{Homeo}(X)$ contains all the topological information about the action.

We shall be interested in actions satisfying the following condition:

- (*) Each $x \in X$ has a neighborhood U such that all the images $g(U)$ for varying $g \in G$ are disjoint. In other words, $g_1(U) \cap g_2(U) \neq \emptyset$ implies $g_1 = g_2$.

Note that it suffices to take g_1 to be the identity since $g_1(U) \cap g_2(U) \neq \emptyset$ is equivalent to $U \cap g_1^{-1}g_2(U) \neq \emptyset$. Thus we have the equivalent condition that $U \cap g(U) \neq \emptyset$ only when g is the identity.

Given an action of a group G on a space X , we can form a space X/G , the quotient space of X in which each point x is identified with all its images $g(x)$ as g ranges over G . The points of X/G are thus the **orbits** $Gx = \{g(x) \mid g \in G\}$ in X , and X/G is called the **orbit space** of the action.

If an action of a group G on a space X satisfies (*), then the quotient map $p: X \rightarrow X/G$, $p(x) = Gx$, is a covering space. For, given an open set $U \subset X$ as in condition (*), the quotient map p simply identifies all the disjoint homeomorphic sets $\{g(U) \mid g \in G\}$ to a single open set $p(U)$ in X/G . By the definition of the quotient topology on X/G , p restricts to a homeomorphism from $g(U)$ onto $p(U)$ for each $g \in G$ so we have a covering space.

In view of this fact, we shall call an action satisfying (*) a **covering space action**. This is not standard terminology, but there does not seem to be a universally accepted name for actions satisfying (*). Sometimes these are called 'properly discontinuous' actions, but more often this rather unattractive term means something weaker: Every point $x \in X$ has a neighborhood U such that $U \cap g(U)$ is nonempty for only finitely many $g \in G$. Many symmetry groups have this proper discontinuity property without satisfying (*), for example the group of symmetries of the familiar tiling of \mathbb{R}^2 by regular hexagons. The reason why the action of this group on \mathbb{R}^2 fails to satisfy (*) is that there are **fixed points**: points x for which there is a nontrivial element $g \in G$ with $g(x) = x$. For example, the vertices of the hexagons are fixed by the 120 degree rotations about these points, and the midpoints of edges are fixed by 180 degree rotations. An action without fixed points is called a **free** action. Thus for a free action of G on X , only the identity element of G fixes any point of X . This is equivalent to requiring that all the images $g(x)$ of each $x \in X$ are distinct, or in other words $g_1(x) = g_2(x)$ only when $g_1 = g_2$, since $g_1(x) = g_2(x)$ is equivalent to $g_1^{-1}g_2(x) = x$. Though condition (*) implies freeness, the converse is not always true. An example is the action of \mathbb{Z} on S^1 in which a generator of \mathbb{Z} acts by rotation through an angle α that is an irrational multiple of 2π . In this case each orbit $\mathbb{Z}y$ is dense in S^1 , so condition (*) cannot hold since it implies that orbits are discrete subspaces. An exercise at the end of the section is to show that for actions on Hausdorff spaces, freeness plus proper discontinuity implies condition (*). Note that proper discontinuity is automatic for actions by a finite group.

Example 1.31. Let X be the closed orientable surface of genus 11, an ‘11-hole torus’ as shown in the figure. This has a 5-fold rotational symmetry, generated by a rotation of angle $2\pi/5$. Thus we have the cyclic group \mathbb{Z}_5 acting on X , and the condition $(*)$ is obviously satisfied. The quotient space X/\mathbb{Z}_5 is a surface of genus 3, obtained from one of the five subsurfaces of X cut off by the circles C_1, \dots, C_5 by identifying its two boundary circles C_i and C_{i+1} to form the circle C as shown. Thus we have a covering space $M_{11} \rightarrow M_3$ where M_g denotes the closed orientable surface of genus g . In particular, we see that $\pi_1(M_3)$ contains the ‘larger’ group $\pi_1(M_{11})$ as a normal subgroup of index 5, with quotient \mathbb{Z}_5 . This example obviously generalizes by replacing the two holes in each ‘arm’ of M_{11} by m holes and the 5-fold symmetry by n -fold symmetry. This gives a covering space $M_{mn+1} \rightarrow M_{m+1}$. An exercise in §2.2 is to show by an Euler characteristic argument that if there is a covering space $M_g \rightarrow M_h$ then $g = mn + 1$ and $h = m + 1$ for some m and n .

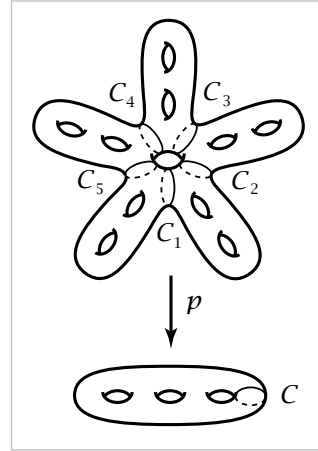

Example 1.32. If the closed orientable surface M_g of genus g is embedded in \mathbb{R}^3 in the standard very symmetric way centered at the origin then the map $x \mapsto -x$ restricts to a homeomorphism τ of M_g generating a covering space action of \mathbb{Z}_2 on M_g . The figure at the right shows the cases $g = 2, 3$, with a spherical ‘bulb’ inserted in the middle of the genus 2 picture to make the two cases look more alike. When $g = 0$ the homeomorphism τ is the antipodal map of S^2 with orbit space $\mathbb{R}P^2$. When $g = 1$ the map τ rotates the longitudinal factor of the torus $S^1 \times S^1$ and reflects the meridional factor, so the orbit space is a Klein bottle. For higher values of g one can regard M_g as being obtained from a sphere or torus by adding symmetric strings of n tori on either side, so the orbit space is a projective plane or Klein bottle with n tori added on. All closed nonorientable surfaces arise this way, so we see that every closed nonorientable surface has a two-sheeted covering space that is a closed orientable surface.

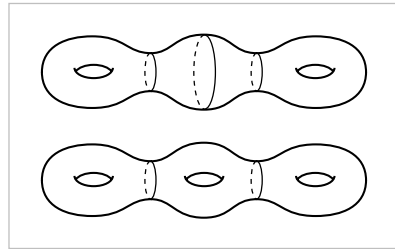

Example 1.33. Consider the grid in \mathbb{R}^2 formed by the horizontal and vertical lines through points in \mathbb{Z}^2 . Let us decorate this grid with arrows in either of the two ways shown in the figure, the difference between the two cases being that in the second case the horizontal arrows in adjacent lines point in opposite directions. The group G consisting of all symmetries of the first decorated grid is isomorphic to $\mathbb{Z} \times \mathbb{Z}$

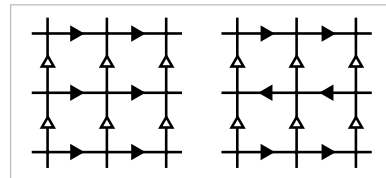

since it consists of all translations $(x, y) \mapsto (x + m, y + n)$ for $m, n \in \mathbb{Z}$. For the second grid the symmetry group G contains a subgroup of translations of the form $(x, y) \mapsto (x + m, y + 2n)$ for $m, n \in \mathbb{Z}$, but there are also glide-reflection symmetries consisting of vertical translation by an odd integer distance followed by reflection across a vertical line, either a vertical line of the grid or a vertical line halfway between two adjacent grid lines. For both decorated grids there are elements of G taking any square to any other, but only the identity element of G takes a square to itself. The minimum distance any point is moved by a nontrivial element of G is 1, which easily implies the covering space condition $(*)$. The orbit space \mathbb{R}^2/G is the quotient space of a square in the grid with opposite edges identified according to the arrows. Thus we see that the fundamental groups of the torus and the Klein bottle are the symmetry groups G in the two cases. In the second case the subgroup of G formed by the translations has index two, and the orbit space for this subgroup is a torus forming a two-sheeted covering space of the Klein bottle.

Theorem 1.34. *For a covering space action of a group G on a simply-connected space X the fundamental group $\pi_1(X/G)$ is isomorphic to G .*

The proof of the theorem depends on a basic lifting property of all covering spaces. Recall from the proof of Theorem 1.7 that for a covering space $p: \tilde{X} \rightarrow X$, a **lift** of a map $f: Y \rightarrow X$ is a map $\tilde{f}: Y \rightarrow \tilde{X}$ such that $p\tilde{f} = f$. The property we need is the **homotopy lifting property**, or **covering homotopy property**, as it is sometimes called:

Proposition 1.35. *Given a covering space $p: \tilde{X} \rightarrow X$, a homotopy $f_t: Y \rightarrow X$, and a map $\tilde{f}_0: Y \rightarrow \tilde{X}$ lifting f_0 , then there exists a unique homotopy $\tilde{f}_t: Y \rightarrow \tilde{X}$ of \tilde{f}_0 that lifts f_t .*

Proof: For the covering space $p: \mathbb{R} \rightarrow S^1$ this is property (c) in the proof of Theorem 1.7, and the proof there applies to any covering space. \square

Taking Y to be a point gives the **path lifting property** for a covering space $p: \tilde{X} \rightarrow X$, which says that for each path $f: I \rightarrow X$ and each lift \tilde{x}_0 of the starting point $f(0) = x_0$ there is a unique path $\tilde{f}: I \rightarrow \tilde{X}$ lifting f starting at \tilde{x}_0 . In particular, the uniqueness of lifts implies that every lift of a constant path is constant, but this could be deduced more simply from the fact that $p^{-1}(x_0)$ has the discrete topology, by the definition of a covering space.

Taking Y to be I , we see that every homotopy f_t of a path f_0 in X lifts to a homotopy \tilde{f}_t of each lift \tilde{f}_0 of f_0 . The lifted homotopy \tilde{f}_t is a homotopy of paths, fixing the endpoints, since as t varies each endpoint of \tilde{f}_t traces out a path lifting a constant path, which must therefore be constant.

Proof of Theorem 1.34: We will construct an explicit isomorphism $\Phi: G \rightarrow \pi_1(X/G)$, defined in the following way. Choose a basepoint $x_0 \in X$. Since X is simply-connected

there is a unique homotopy class of paths γ connecting x_0 to $g(x_0)$ for each $g \in G$. The composition of γ with the projection $p: X \rightarrow X/G$ is then a loop in X/G , and we let $\Phi(g)$ be the homotopy class of this loop.

To see that Φ is a homomorphism, let γ_1 and γ_2 be paths from x_0 to $g_1(x_0)$ and $g_2(x_0)$. The composed path $\gamma_1 \cdot (g_1\gamma_2)$ then goes from x_0 to $g_1g_2(x_0)$. This path projects to $(p\gamma_1) \cdot (p\gamma_2)$, so $\Phi(g_1g_2) = \Phi(g_1)\Phi(g_2)$.

Using the same notation we can also see that Φ is injective. For suppose $\Phi(g_1) = \Phi(g_2)$, so the loops $p\gamma_1$ and $p\gamma_2$ are homotopic. The homotopy lifting property then gives a homotopy of γ_1 to a path which must be γ_2 since it starts at the same point as γ_2 and has the same projection to X/G , data which determine γ_2 uniquely by the uniqueness part of the path lifting property. Thus γ_1 and γ_2 are homotopic, and in particular they have the same endpoint $g_1(x_0) = g_2(x_0)$, which implies $g_1 = g_2$ since we have a covering space action.

Surjectivity of Φ follows from the path lifting property since any loop in X/G at the basepoint $p(x_0)$ lifts to a path γ in X starting at x_0 and ending at a point x_1 which must equal $g(x_0)$ for some $g \in G$ since the projection $p\gamma$ is a loop. \square

Cayley Complexes

Covering spaces can be used to describe a very classical method for viewing groups geometrically as graphs. Recall from Corollary 1.28 how we associated to each group presentation $G = \langle g_\alpha \mid r_\beta \rangle$ a 2-dimensional cell complex X_G with $\pi_1(X_G) \approx G$ by taking a wedge-sum of circles, one for each generator g_α , and then attaching a 2-cell for each relator r_β . We can construct a cell complex \tilde{X}_G with a covering space action of G such that $\tilde{X}_G/G = X_G$ in the following way. Let the vertices of \tilde{X}_G be the elements of G themselves. Then, at each vertex $g \in G$, insert an edge joining g to the vertex gg_α for each of the chosen generators g_α . The resulting graph is known as the **Cayley graph** of G with respect to the generators g_α . Each relation r_β determines a loop in the graph starting at any vertex g and passing across the edges corresponding to the successive letters of r_β , returning in the end to the vertex g since $gr_\beta = g$ in G . After we attach a 2-cell for each such loop, we have a cell complex \tilde{X}_G called the **Cayley complex** of G . The group G acts on \tilde{X}_G by multiplication on the left. Thus, an element $g \in G$ sends a vertex $g' \in G$ to the vertex gg' , and the edge from g' to $g'g_\alpha$ is sent to the edge from gg' to $gg'g_\alpha$. The action extends to 2-cells in the obvious way. This is clearly a covering space action, and the orbit space is just X_G .

The Cayley complex \tilde{X}_G is in fact simply-connected. It is path-connected since every element of G is a product of g_α 's, so there is a sequence of edges joining each vertex to the identity vertex e . To see that $\pi_1(\tilde{X}_G) = 0$, start with a loop at the basepoint vertex e . This loop is homotopic to a loop in the 1-skeleton consisting of a finite sequence of edges, corresponding to a word w in the generators g_α and their inverses. Since this sequence of edges is a loop, the word w , viewed as an element

of G , is the identity, so as an element of the free group generated by the g_α 's the word w can be written as a product of conjugates of the r_β 's and their inverses. This means that the loop is homotopic in the 1-skeleton to a product of loops each of which consists of three parts: a path from the basepoint to a vertex in the boundary of some 2-cell, followed by the boundary loop of this 2-cell, and finishing with the inverse of the path from the basepoint. Such loops are evidently nullhomotopic in \tilde{X}_G , so the original loop was also nullhomotopic.

Let us look at some examples of Cayley complexes.

Example 1.36. When G is the free group on two generators a and b , X_G is $S^1 \vee S^1$ and \tilde{X}_G is the Cayley graph of $\mathbb{Z} * \mathbb{Z}$ pictured at the right. The action of a on this graph is a rightward shift along the central horizontal axis, while b acts by an upward shift along the central vertical axis. The composition ab of these two shifts then takes the vertex e to the vertex ab . Similarly, the action of any $w \in \mathbb{Z} * \mathbb{Z}$ takes e to the vertex w .

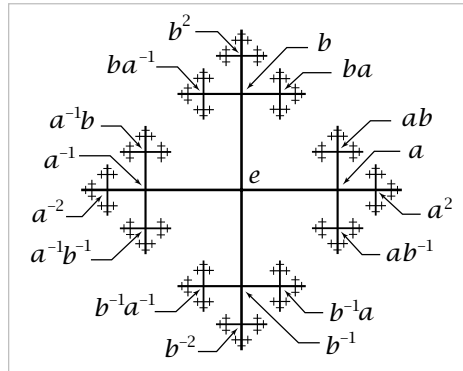

Example 1.37. For $G = \mathbb{Z}_2 = \langle a \mid a^2 \rangle$, X_G is $\mathbb{R}P^2$ and $\tilde{X}_G = S^2$. More generally, for $\mathbb{Z}_n = \langle a \mid a^n \rangle$, X_G is S^1 with a disk attached by the map $z \mapsto z^n$ and \tilde{X}_G consists of n disks D_1, \dots, D_n with their boundary circles identified. A generator of \mathbb{Z}_n acts on this union of disks by sending D_i to D_{i+1} via a $2\pi/n$ rotation, the subscript i being taken mod n . The common boundary circle of the disks is rotated by $2\pi/n$.

Example 1.38. The group $G = \mathbb{Z} \times \mathbb{Z}$ with presentation $\langle a, b \mid aba^{-1}b^{-1} \rangle$ has X_G the torus $S^1 \times S^1$, and \tilde{X}_G is \mathbb{R}^2 with vertices the integer lattice $\mathbb{Z}^2 \subset \mathbb{R}^2$ and edges the horizontal and vertical segments between these lattice points. This is the first figure in Example 1.33, with the addition of labels a on the horizontal edges, b on the vertical edges, and with the integer lattice point (m, n) labeled by the element $a^m b^n \in G$.

Example 1.39. The Klein bottle is X_G for $G = \langle a, b \mid abab^{-1} \rangle$. Here \tilde{X}_G is shown in the second figure of Example 1.33 with exactly the same labeling of vertices and edges as in the preceding example of the torus. In particular, elements of G are again uniquely representable as products $a^m b^n$. But with arrows in alternate horizontal rows going in opposite directions, the rule for multiplication of such products becomes $a^m b^n a^p b^q = a^{m \pm p} b^{n+q}$, the \pm being $+$ when n is even and $-$ when n is odd. This formula can be read off directly from the Cayley graph.

If we modify this group by adding the new relator b^2 we obtain the infinite dihedral group D_∞ . The Cayley graph in this case can be drawn on an infinite cylinder, the quotient of the previous Cayley complex \mathbb{R}^2 by vertical translation by even integer

distances. The Cayley complex for D_∞ is obtained from this cylinder by inserting an infinite sequence of inscribed spheres formed from pairs of 2-cells attached along each relator cycle b^2 .

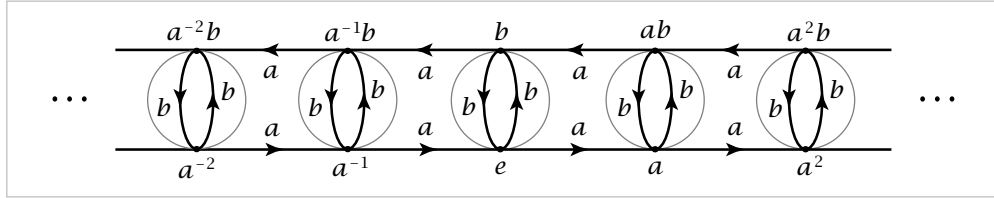

As a further variant, if we add the relator a^n as well as b^2 we obtain the finite dihedral group D_{2n} of order $2n$. The Cayley graph lies on a torus, the quotient of the previous infinite cylinder by horizontal translation by n units. The Cayley complex has the inscribed spheres and also n 2-cells attached along each of the two a^n cycles. The figure at the right shows the case $n = 5$. The usual action of D_{2n} on a regular n -gon is not free, and the Cayley graph can be regarded as an exploded version of the n -gon that makes the action free. Vertices of the n -gon are replaced by circles in the Cayley graph, and each edge of the n -gon is replaced by two parallel edges.

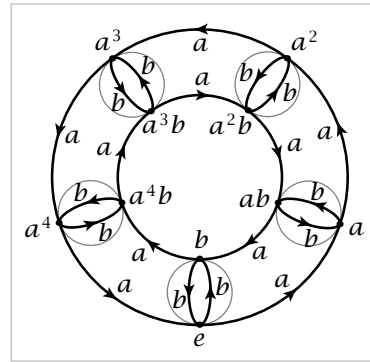

Example 1.40. If $G = \mathbb{Z}_2 * \mathbb{Z}_2 = \langle a, b \mid a^2, b^2 \rangle$ then the Cayley graph is a union of an infinite sequence of circles each tangent to its two neighbors.

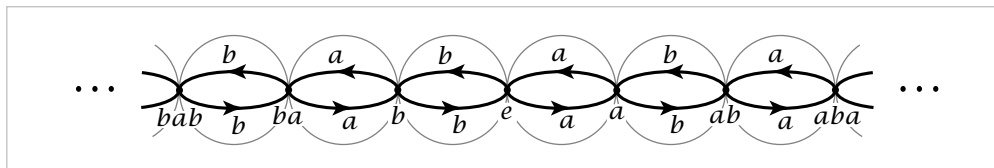

We obtain \tilde{X}_G from this graph by making each circle the equator of a 2-sphere, yielding an infinite sequence of tangent 2-spheres. Elements of the index-two normal subgroup $\mathbb{Z} \subset \mathbb{Z}_2 * \mathbb{Z}_2$ generated by ab act on \tilde{X}_G as translations by an even number of units, while each of the remaining elements of $\mathbb{Z}_2 * \mathbb{Z}_2$ acts as the antipodal map on one of the spheres and flips the whole chain of spheres end-for-end about this sphere. The orbit space X_G is $\mathbb{RP}^2 \vee \mathbb{RP}^2$.

The Cayley graph for $\mathbb{Z}_2 * \mathbb{Z}_2$ may look a little like the earlier Cayley graph for the infinite dihedral group D_∞ , and in fact these two groups are isomorphic, with the elements a and b in D_∞ corresponding to ab and b in $\mathbb{Z}_2 * \mathbb{Z}_2$. Geometrically, it is obvious that the symmetry groups of the two Cayley graphs are isomorphic. Thus we see that two different presentations for the same group can have different Cayley graphs, but not so different that their symmetry groups are different. As another example, the Cayley graph for the presentation $\langle a, b \mid a^2, b^2, (ab)^n \rangle$ of D_{2n} is a

‘necklace’ of $2n$ circles, obtained from the Cayley graph of $\mathbb{Z}_2 * \mathbb{Z}_2$ by factoring out a translation.

It is not hard to see the generalization of the $\mathbb{Z}_2 * \mathbb{Z}_2$ example to $\mathbb{Z}_m * \mathbb{Z}_n$ with the presentation $\langle a, b \mid a^m, b^n \rangle$. In this case \tilde{X}_G consists of an infinite union of copies of the Cayley complexes for \mathbb{Z}_m and \mathbb{Z}_n constructed in Example 1.37, arranged in a tree-like pattern. The case of $\mathbb{Z}_2 * \mathbb{Z}_3$ is pictured below.

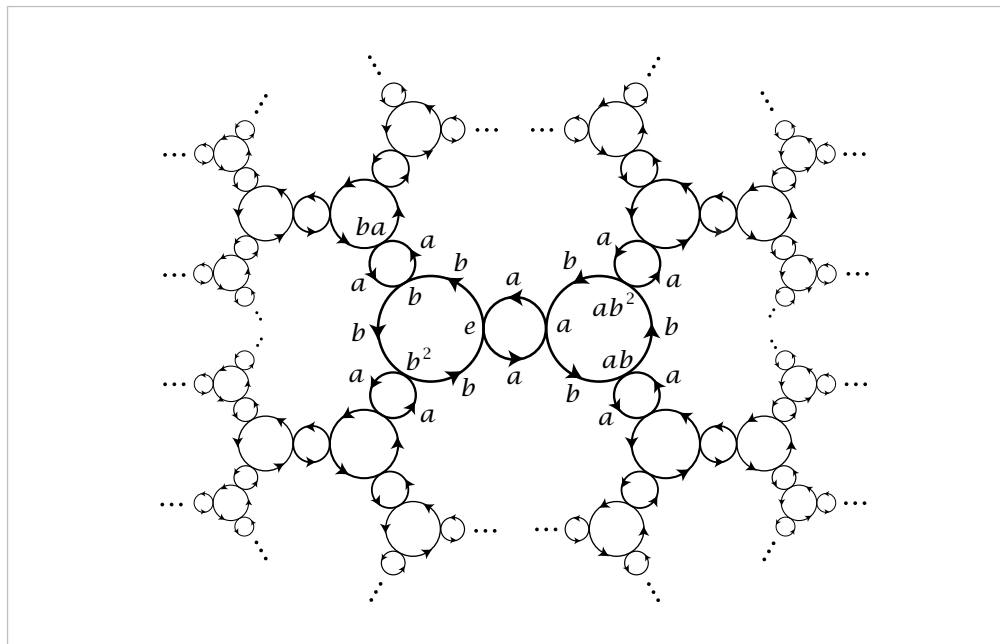

Groups Acting on Spheres

Example 1.41: $\mathbb{R}P^n$. The antipodal map of S^n , $x \mapsto -x$, generates an action of \mathbb{Z}_2 on S^n with orbit space $\mathbb{R}P^n$, real projective n -space, as defined in Example 0.4. The action is a covering space action since each open hemisphere in S^n is disjoint from its antipodal image. As we saw in Proposition 1.14, S^n is simply-connected if $n \geq 2$, so from the covering space $S^n \rightarrow \mathbb{R}P^n$ we deduce that $\pi_1(\mathbb{R}P^n) \approx \mathbb{Z}_2$ for $n \geq 2$. A generator for $\pi_1(\mathbb{R}P^n)$ is any loop obtained by projecting a path in S^n connecting two antipodal points. One can see explicitly that such a loop γ has order two in $\pi_1(\mathbb{R}P^n)$ if $n \geq 2$ since the composition $\gamma \cdot \gamma$ lifts to a loop in S^n , and this can be homotoped to the trivial loop since $\pi_1(S^n) = 0$, so the projection of this homotopy into $\mathbb{R}P^n$ gives a nullhomotopy of $\gamma \cdot \gamma$.

One may ask whether there are other finite groups that act freely on S^n , defining covering spaces $S^n \rightarrow S^n/G$. We will show in Proposition 2.29 that \mathbb{Z}_2 is the only possibility when n is even, but for odd n the question is much more difficult. It is easy to construct a free action of any cyclic group \mathbb{Z}_m on S^{2k-1} , the action generated by the rotation $v \mapsto e^{2\pi i/m}v$ of the unit sphere S^{2k-1} in $\mathbb{C}^k = \mathbb{R}^{2k}$. This action is free

since an equation $v = e^{2\pi i \ell/m} v$ with $0 < \ell < m$ implies $v = 0$, but 0 is not a point of S^{2k-1} . The orbit space S^{2k-1}/\mathbb{Z}_m is one of a family of spaces called *lens spaces* defined in Example 2.43.

There are also noncyclic finite groups that act freely as rotations of S^n for odd $n > 1$. These actions are classified quite explicitly in [Wolf 1984]. Examples in the simplest case $n = 3$ can be produced as follows. View \mathbb{R}^4 as the quaternion algebra \mathbb{H} . Multiplication of quaternions satisfies $|ab| = |a||b|$ where $|a|$ denotes the usual Euclidean length of a vector $a \in \mathbb{R}^4$. Thus if a and b are unit vectors, so is ab , and hence quaternion multiplication defines a map $S^3 \times S^3 \rightarrow S^3$. This in fact makes S^3 into a group, though associativity is all we need now since associativity implies that any subgroup G of S^3 acts on S^3 by left-multiplication, $g(x) = gx$. This action is free since an equation $x = gx$ in the division algebra \mathbb{H} implies $g = 1$ or $x = 0$. As a concrete example, G could be the familiar quaternion group $Q_8 = \{\pm 1, \pm i, \pm j, \pm k\}$ from group theory. More generally, for a positive integer m , let Q_{4m} be the subgroup of S^3 generated by the two quaternions $a = e^{\pi i/m}$ and $b = j$. Thus a has order $2m$ and b has order 4. The easily verified relations $a^m = b^2 = -1$ and $bab^{-1} = a^{-1}$ imply that the subgroup \mathbb{Z}_{2m} generated by a is normal and of index 2 in Q_{4m} . Hence Q_{4m} is a group of order $4m$, called the *generalized quaternion group*. Another common name for this group is the *binary dihedral group* D_{4m}^* since its quotient by the subgroup $\{\pm 1\}$ is the ordinary dihedral group D_{2m} of order $2m$.

Besides the groups $Q_{4m} = D_{4m}^*$ there are just three other noncyclic finite subgroups of S^3 : the binary tetrahedral, octahedral, and icosahedral groups T_{24}^* , O_{48}^* , and I_{120}^* , of orders indicated by the subscripts. These project two-to-one onto the groups of rotational symmetries of a regular tetrahedron, octahedron (or cube), and icosahedron (or dodecahedron). In fact, it is not hard to see that the homomorphism $S^3 \rightarrow SO(3)$ sending $u \in S^3 \subset \mathbb{H}$ to the isometry $v \rightarrow u^{-1}vu$ of \mathbb{R}^3 , viewing \mathbb{R}^3 as the ‘pure imaginary’ quaternions $v = ai + bj + ck$, is surjective with kernel $\{\pm 1\}$. Then the groups D_{4m}^* , T_{24}^* , O_{48}^* , I_{120}^* are the preimages in S^3 of the groups of rotational symmetries of a regular polygon or polyhedron in \mathbb{R}^3 .

There are two conditions that a finite group G acting freely on S^n must satisfy:

- (a) Every abelian subgroup of G is cyclic. This is equivalent to saying that G contains no subgroup $\mathbb{Z}_p \times \mathbb{Z}_p$ with p prime.
- (b) G contains at most one element of order 2.

A proof of (a) is sketched in an exercise for §4.2. For a proof of (b) the original source [Milnor 1957] is recommended reading. The groups satisfying (a) have been completely classified; see [Brown 1982], section VI.9, for details. An example of a group satisfying (a) but not (b) is the dihedral group D_{2m} for odd $m > 1$.

There is also a much more difficult converse: A finite group satisfying (a) and (b) acts freely on S^n for some n . References for this are [Madsen, Thomas, & Wall 1976] and [Davis & Milgram 1985]. There is also almost complete information about which

n 's are possible for a given group.

One More Example

Let us illustrate how one might build a simply-connected covering space of a given space by gluing together simply-connected covering spaces of various simpler pieces of the space.

Example 1.42. For integers $m, n \geq 2$, let $X_{m,n}$ be the quotient space of a cylinder $S^1 \times I$ under the identifications $(z, 0) \sim (e^{2\pi i/m} z, 0)$ and $(z, 1) \sim (e^{2\pi i/n} z, 1)$. Let $A \subset X$ and $B \subset X$ be the quotients of $S^1 \times [0, 1/2]$ and $S^1 \times [1/2, 1]$, so A and B are the mapping cylinders of $z \mapsto z^m$ and $z \mapsto z^n$, with $A \cap B = S^1$. The simplest case is $m = n = 2$, when A and B are Möbius bands and $X_{2,2}$ is the Klein bottle. The complexes $X_{m,n}$ appeared earlier in this chapter in connection with torus knots, in Example 1.24.

The figure for Example 1.29 at the end of the preceding section shows what A looks like in the typical case $m = 3$. We have $\pi_1(A) \approx \mathbb{Z}$, and the universal cover \tilde{A} is homeomorphic to a product $C_m \times \mathbb{R}$ where C_m is the graph that is a cone on m points, as shown in the figure to the right. The situation for B is similar, and \tilde{B} is homeomorphic to $C_n \times \mathbb{R}$. Now we attempt to build the universal cover $\tilde{X}_{m,n}$ from copies of \tilde{A} and \tilde{B} . Start with a copy of \tilde{A} . Its boundary, the outer edges of its fins, consists of m copies of \mathbb{R} . Along each of these m boundary lines we attach a copy of \tilde{B} . Each of these copies of \tilde{B} has one of its boundary lines attached to the initial copy of \tilde{A} , leaving $n - 1$ boundary lines free, and we attach a new copy of \tilde{A} to each of these free boundary lines. Thus we now have $m(n - 1) + 1$ copies of \tilde{A} . Each of the newly attached copies of \tilde{A} has $m - 1$ free boundary lines, and to each of these lines we attach a new copy of \tilde{B} . The process is now repeated ad infinitum in the evident way. Let $\tilde{X}_{m,n}$ be the resulting space.

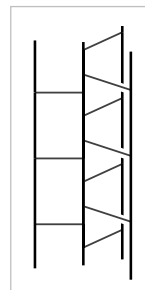

The product structures $\tilde{A} = C_m \times \mathbb{R}$ and $\tilde{B} = C_n \times \mathbb{R}$ give $\tilde{X}_{m,n}$ the structure of a product $T_{m,n} \times \mathbb{R}$ where $T_{m,n}$ is an infinite graph constructed by an inductive scheme just like the construction of $\tilde{X}_{m,n}$. Thus $T_{m,n}$ is the union of a sequence of finite subgraphs, each obtained from the preceding by attaching new copies of C_m or C_n . Each of these finite subgraphs deformation retracts onto the preceding one. The infinite concatenation of these deformation retractions, with the k^{th} graph deformation retracting to the previous one during the time interval $[1/2^k, 1/2^{k-1}]$, gives a deformation retraction of $T_{m,n}$ onto the initial stage C_m . Since C_m is contractible, this means $T_{m,n}$ is contractible, hence also $\tilde{X}_{m,n}$, which is the product $T_{m,n} \times \mathbb{R}$. In particular, $\tilde{X}_{m,n}$ is simply-connected.

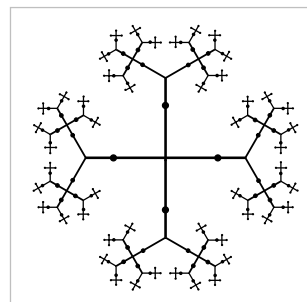

The map that projects each copy of \tilde{A} in $\tilde{X}_{m,n}$ to A and each copy of \tilde{B} to B is a covering space. To define this map precisely, choose a point $x_0 \in S^1$, and then the image of the line segment $\{x_0\} \times I$ in $X_{m,n}$ meets A in a line segment whose preimage in \tilde{A} consists of an infinite number of line segments, appearing in the earlier figure as the horizontal segments spiraling around the central vertical axis. The picture in \tilde{B} is similar, and when we glue together all the copies of \tilde{A} and \tilde{B} to form $\tilde{X}_{m,n}$, we do so in such a way that these horizontal segments always line up exactly. This decomposes $\tilde{X}_{m,n}$ into infinitely many rectangles, each formed from a rectangle in an \tilde{A} and a rectangle in a \tilde{B} . The covering projection $\tilde{X}_{m,n} \rightarrow X_{m,n}$ is the quotient map that identifies all these rectangles.

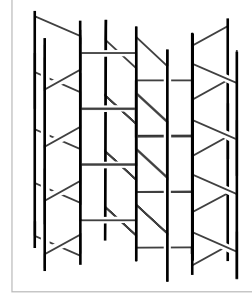

The rectangles define a cell structure on $\tilde{X}_{m,n}$ lifting a cell structure on $X_{m,n}$ with two vertices, three edges, and one 2-cell. Suppose we orient and label the three edges of $X_{m,n}$ and lift these orientations and labels to the edges of $\tilde{X}_{m,n}$. The symmetries of $\tilde{X}_{m,n}$ preserving the orientations and labels of edges form a group $G_{m,n}$. The action of this group on $\tilde{X}_{m,n}$ is a covering space action, and the quotient $\tilde{X}_{m,n}/G_{m,n}$ is just $X_{m,n}$ since for any two rectangles in $\tilde{X}_{m,n}$ there is an element of $G_{m,n}$ taking one rectangle to the other. By Theorem 1.34 the group $G_{m,n}$ is therefore isomorphic to $\pi_1(X_{m,n})$. From van Kampen's theorem applied to the decomposition of $X_{m,n}$ into the two mapping cylinders we have the presentation $\langle a, b \mid a^m b^{-n} \rangle$ for this group $G_{m,n} = \pi_1(X_{m,n})$. The element a for example acts on $\tilde{X}_{m,n}$ as a 'screw motion' about an axis that is a vertical line $\{v_a\} \times \mathbb{R}$ with v_a a vertex of $T_{m,n}$, and b acts similarly for an adjacent vertex v_b .

Since the action of $G_{m,n}$ on $\tilde{X}_{m,n}$ preserves the cell structure, it also preserves the product structure $T_{m,n} \times \mathbb{R}$. This means that there are actions of $G_{m,n}$ on $T_{m,n}$ and \mathbb{R} such that the action on the product $X_{m,n} = T_{m,n} \times \mathbb{R}$ is the diagonal action $g(x, y) = (g(x), g(y))$ for $g \in G_{m,n}$. If we make the rectangles of unit height in the \mathbb{R} coordinate, then the element $a^m = b^n$ acts on \mathbb{R} as unit translation, while a acts by $1/m$ translation and b by $1/n$ translation. The translation actions of a and b on \mathbb{R} generate a group of translations of \mathbb{R} that is infinite cyclic, generated by translation by the reciprocal of the least common multiple of m and n .

The action of $G_{m,n}$ on $T_{m,n}$ has kernel consisting of the powers of the element $a^m = b^n$. This infinite cyclic subgroup is precisely the center of $G_{m,n}$, as we saw in Example 1.24. There is an induced action of the quotient group $\mathbb{Z}_m * \mathbb{Z}_n$ on $T_{m,n}$, but this is not a free action since the elements a and b and all their conjugates fix vertices of $T_{m,n}$. On the other hand, if we restrict the action of $G_{m,n}$ on $T_{m,n}$ to the kernel K of the map $G_{m,n} \rightarrow \mathbb{Z}$ given by the action of $G_{m,n}$ on the \mathbb{R} factor of $X_{m,n}$, then we do obtain a free action of K on $T_{m,n}$. Since this action takes vertices to vertices and edges to edges, it is a covering space action, so K is a free group, the

fundamental group of the graph $T_{m,n}/K$. An exercise at the end of the section is to determine $T_{m,n}/K$ explicitly and compute the number of generators of K .

The Classification of Covering Spaces

Our objective now is to develop the necessary tools to classify all the different covering spaces of a fixed path-connected space X . The main thrust of the classification will be the Galois correspondence between connected covering spaces of X and subgroups of $\pi_1(X)$, but when this is finished we will also describe a different method of classification that includes disconnected covering spaces as well.

The Galois correspondence will be a classification up to isomorphism, where this term has its most natural definition: An **isomorphism** between covering spaces $p_1: \tilde{X}_1 \rightarrow X$ and $p_2: \tilde{X}_2 \rightarrow X$ is a homeomorphism $f: \tilde{X}_1 \rightarrow \tilde{X}_2$ such that $p_1 = p_2 f$. This condition means exactly that f preserves the covering space structures, taking $p_1^{-1}(x)$ to $p_2^{-1}(x)$ for each $x \in X$. The inverse f^{-1} is then also an isomorphism, and the composition of two isomorphisms is an isomorphism, so we have an equivalence relation.

The correspondence between isomorphism classes of connected covering spaces of X and subgroups of $\pi_1(X)$ will be given by the function Γ sending a covering space $p: (\tilde{X}, \tilde{x}_0) \rightarrow (X, x_0)$ to the subgroup $\Gamma(\tilde{X}, \tilde{x}_0) = p_*(\pi_1(\tilde{X}, \tilde{x}_0))$ of $\pi_1(X, x_0)$.

Let us make a few preliminary observations about the subgroups $\Gamma(\tilde{X}, \tilde{x}_0)$.

Proposition 1.43. *The map $p_*: \pi_1(\tilde{X}, \tilde{x}_0) \rightarrow \pi_1(X, x_0)$ induced by a covering space $p: (\tilde{X}, \tilde{x}_0) \rightarrow (X, x_0)$ is injective. The image subgroup $\Gamma(\tilde{X}, \tilde{x}_0)$ in $\pi_1(X, x_0)$ consists of the homotopy classes of loops in X based at x_0 whose lifts to \tilde{X} starting at \tilde{x}_0 are loops.*

Proof: An element of the kernel of p_* is represented by a loop $\tilde{y}_0: I \rightarrow \tilde{X}$ with a homotopy $y_t: I \rightarrow X$ of $y_0 = p\tilde{y}_0$ to the trivial loop y_1 . This homotopy lifts to a homotopy of loops \tilde{y}_t starting with \tilde{y}_0 and ending with a constant loop since the only lift of a constant loop is a constant loop. Hence $[\tilde{y}_0] = 0$ in $\pi_1(\tilde{X}, \tilde{x}_0)$ and p_* is injective.

For the second statement of the proposition, loops at x_0 lifting to loops at \tilde{x}_0 certainly represent elements of the image of $p_*: \pi_1(\tilde{X}, \tilde{x}_0) \rightarrow \pi_1(X, x_0)$. Conversely, a loop representing an element of the image of p_* is homotopic to a loop with a lift to a loop at \tilde{x}_0 , so by lifting the homotopy we see that the original loop must itself lift to a loop at \tilde{x}_0 . \square

Proposition 1.44. *The number of sheets of a covering space $p: (\tilde{X}, \tilde{x}_0) \rightarrow (X, x_0)$ with X and \tilde{X} path-connected equals the index of $\Gamma(\tilde{X}, \tilde{x}_0)$ in $\pi_1(X, x_0)$.*

Proof: For a loop γ in X based at x_0 , let $\tilde{\gamma}$ be its lift to \tilde{X} starting at \tilde{x}_0 . A product $\eta \cdot \gamma$ with $[\eta] \in H = \Gamma(\tilde{X}, \tilde{x}_0)$ has the lift $\tilde{\eta} \cdot \tilde{\gamma}$ ending at the same point as $\tilde{\gamma}$ since $\tilde{\eta}$

is a loop. Thus we may define a function Φ from cosets $H[\gamma]$ to $p^{-1}(x_0)$ by sending $H[\gamma]$ to $\tilde{\gamma}(1)$. The path-connectedness of \tilde{X} implies that Φ is surjective since \tilde{x}_0 can be joined to any point in $p^{-1}(x_0)$ by a path $\tilde{\gamma}$ projecting to a loop γ at x_0 . To see that Φ is injective, observe that $\Phi(H[\gamma_1]) = \Phi(H[\gamma_2])$ implies that $\gamma_1\bar{\gamma}_2$ lifts to a loop in \tilde{X} based at \tilde{x}_0 , so $[\gamma_1][\gamma_2]^{-1} \in H$ and hence $H[\gamma_1] = H[\gamma_2]$. \square

Now we describe how the subgroup $\Gamma(\tilde{X}, \tilde{x}_0)$ depends on the choice of \tilde{x}_0 .

Lemma 1.45. *Given a covering space $p: (\tilde{X}, \tilde{x}_0) \rightarrow (X, x_0)$, let γ be a loop in X at x_0 representing a class $g \in \pi_1(X, x_0)$ and lifting to a path $\tilde{\gamma}$ starting at \tilde{x}_0 and ending at a point $\tilde{x}_1 \in p^{-1}(x_0)$. Then $\Gamma(\tilde{X}, \tilde{x}_0) = g\Gamma(\tilde{X}, \tilde{x}_1)g^{-1}$.*

Thus any subgroup of $\pi_1(X, x_0)$ conjugate to $\Gamma(\tilde{X}, \tilde{x}_0)$ corresponds to the same covering space \tilde{X} with a different choice of basepoint \tilde{x}_0 in $p^{-1}(x_0)$. Conversely, if \tilde{X} is path-connected we can choose γ to be the projection of a path joining any two choices of basepoint in $p^{-1}(x_0)$ to deduce that the conjugacy class of $\Gamma(\tilde{X}, \tilde{x}_0)$ is independent of the choice of \tilde{x}_0 within $p^{-1}(x_0)$.

Proof: Represent an element of $\Gamma(\tilde{X}, \tilde{x}_1)$ by a loop η lifting to a loop $\tilde{\eta}$ at \tilde{x}_1 . Then $\tilde{\gamma}\tilde{\eta}\bar{\tilde{\gamma}}$ is a loop at \tilde{x}_0 lifting $\gamma\eta\bar{\gamma}$, so $g\Gamma(\tilde{X}, \tilde{x}_1)g^{-1} \subset \Gamma(\tilde{X}, \tilde{x}_0)$. The opposite inclusion is equivalent to $g^{-1}\Gamma(\tilde{X}, \tilde{x}_0)g \subset \Gamma(\tilde{X}, \tilde{x}_1)$ which holds by the same reasoning, replacing γ with $\bar{\gamma}$ and interchanging \tilde{x}_0 and \tilde{x}_1 . \square

To proceed further with the classification of covering spaces we need two basic propositions on the existence and uniqueness of lifts of general maps. For the existence question an answer is provided by the following **lifting criterion**:

Proposition 1.46. *Suppose $p: (\tilde{X}, \tilde{x}_0) \rightarrow (X, x_0)$ is a covering space. Then a map $f: (Y, y_0) \rightarrow (X, x_0)$ whose domain Y is path-connected and locally path-connected has a lift $\tilde{f}: (Y, y_0) \rightarrow (\tilde{X}, \tilde{x}_0)$ iff $f_*(\pi_1(Y, y_0)) \subset p_*(\pi_1(\tilde{X}, \tilde{x}_0))$.*

Proof: The ‘only if’ statement is obvious since $f_* = p_*\tilde{f}_*$. For the converse, let $y \in Y$ and let γ be a path in Y from y_0 to y . The path $f\gamma$ in X starting at x_0 has a unique lift $\tilde{f}\gamma$ starting at \tilde{x}_0 . Define $\tilde{f}(y) = \tilde{f}\gamma(1)$. To show this is well-defined, independent of the choice of γ , let γ' be another path from y_0 to y . Then $(f\gamma') \cdot \overline{(f\gamma)}$ is a loop at x_0 representing an element of $f_*(\pi_1(Y, y_0)) \subset p_*(\pi_1(\tilde{X}, \tilde{x}_0))$.

By Proposition 1.43 the loop $(f\gamma') \cdot \overline{(f\gamma)}$ lifts to a loop at

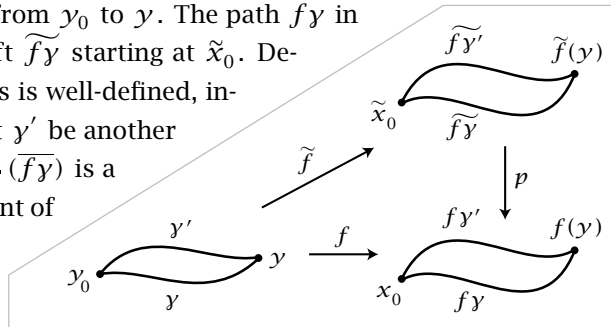

\tilde{x}_0 . By the uniqueness of lifted paths, the first half of this lift is $\tilde{f}\gamma'$ and the second

half is $\widetilde{f}\gamma$ traversed backwards, with the common midpoint $\widetilde{f}\gamma(1) = \widetilde{f}\gamma'(1)$. This shows that \widetilde{f} is well-defined.

To see that \widetilde{f} is continuous, let $U \subset X$ be an open neighborhood of $f(\gamma)$ having a lift $\widetilde{U} \subset \widetilde{X}$ containing $\widetilde{f}(\gamma)$ such that $p:\widetilde{U} \rightarrow U$ is a homeomorphism. Choose a path-connected open neighborhood V of γ with $f(V) \subset U$. For paths from γ_0 to points $\gamma' \in V$ we can take a fixed path γ from γ_0 to γ followed by paths η in V from γ to the points γ' . Then the paths $(f\gamma) \cdot (f\eta)$ in X have lifts $(\widetilde{f}\gamma) \cdot (\widetilde{f}\eta)$ where $\widetilde{f}\eta = p^{-1}f\eta$ and $p^{-1}:U \rightarrow \widetilde{U}$ is the inverse of $p:\widetilde{U} \rightarrow U$. Thus $\widetilde{f}(V) \subset \widetilde{U}$ and $\widetilde{f}|_V = p^{-1}f$, hence \widetilde{f} is continuous at γ . \square

An example showing the necessity of the local path-connectedness assumption on Y is described in Exercise 7 at the end of this section.

Next we have the **unique lifting property**:

Proposition 1.47. *Given a covering space $p:\widetilde{X} \rightarrow X$ and a map $f:Y \rightarrow X$ with two lifts $\widetilde{f}_1, \widetilde{f}_2:Y \rightarrow \widetilde{X}$ that agree at one point of Y , then if Y is connected, these two lifts must agree on all of Y .*

Proof: For a point $\gamma \in Y$, let U be an open neighborhood of $f(\gamma)$ in X for which $p^{-1}(U)$ is a disjoint union of open sets \widetilde{U}_α each mapped homeomorphically to U by p , and let \widetilde{U}_1 and \widetilde{U}_2 be the \widetilde{U}_α 's containing $\widetilde{f}_1(\gamma)$ and $\widetilde{f}_2(\gamma)$, respectively. By continuity of \widetilde{f}_1 and \widetilde{f}_2 there is a neighborhood N of γ mapped into \widetilde{U}_1 by \widetilde{f}_1 and into \widetilde{U}_2 by \widetilde{f}_2 . If $\widetilde{f}_1(\gamma) \neq \widetilde{f}_2(\gamma)$ then $\widetilde{U}_1 \neq \widetilde{U}_2$, hence $\widetilde{U}_1 \cap \widetilde{U}_2 = \emptyset$ and $\widetilde{f}_1 \neq \widetilde{f}_2$ throughout the neighborhood N . On the other hand, if $\widetilde{f}_1(\gamma) = \widetilde{f}_2(\gamma)$ then $\widetilde{U}_1 = \widetilde{U}_2$ so $\widetilde{f}_1 = \widetilde{f}_2$ on N since $p\widetilde{f}_1 = p\widetilde{f}_2$ and p is injective on $\widetilde{U}_1 = \widetilde{U}_2$. Thus the set of points where \widetilde{f}_1 and \widetilde{f}_2 agree is both open and closed in Y , so it must be all of Y if Y is connected. \square

Here is the uniqueness half of the Galois correspondence:

Theorem 1.48. *If X is path-connected and locally path-connected, then two path-connected covering spaces $p_1:\widetilde{X}_1 \rightarrow X$ and $p_2:\widetilde{X}_2 \rightarrow X$ are isomorphic via an isomorphism $f:\widetilde{X}_1 \rightarrow \widetilde{X}_2$ taking a basepoint $\widetilde{x}_1 \in p_1^{-1}(x_0)$ to a basepoint $\widetilde{x}_2 \in p_2^{-1}(x_0)$ iff $\Gamma(\widetilde{X}_1, \widetilde{x}_1) = \Gamma(\widetilde{X}_2, \widetilde{x}_2)$. The covering spaces \widetilde{X}_1 and \widetilde{X}_2 are isomorphic without regard to basepoints iff $\Gamma(\widetilde{X}_1, \widetilde{x}_1)$ and $\Gamma(\widetilde{X}_2, \widetilde{x}_2)$ are conjugate subgroups of $\pi_1(X, x_0)$.*

Proof: If there is an isomorphism $f:(\widetilde{X}_1, \widetilde{x}_1) \rightarrow (\widetilde{X}_2, \widetilde{x}_2)$, then from the two relations $p_1 = p_2f$ and $p_2 = p_1f^{-1}$ it follows that $\Gamma(\widetilde{X}_1, \widetilde{x}_1) = \Gamma(\widetilde{X}_2, \widetilde{x}_2)$. Conversely, suppose that $\Gamma(\widetilde{X}_1, \widetilde{x}_1) = \Gamma(\widetilde{X}_2, \widetilde{x}_2)$. By the lifting criterion, we may lift p_1 to a map $\widetilde{p}_1:(\widetilde{X}_1, \widetilde{x}_1) \rightarrow (\widetilde{X}_2, \widetilde{x}_2)$ with $p_2\widetilde{p}_1 = p_1$. Similarly, we obtain $\widetilde{p}_2:(\widetilde{X}_2, \widetilde{x}_2) \rightarrow (\widetilde{X}_1, \widetilde{x}_1)$ with $p_1\widetilde{p}_2 = p_2$. Then by the unique lifting property, $\widetilde{p}_1\widetilde{p}_2 = \mathbb{1}$ and $\widetilde{p}_2\widetilde{p}_1 = \mathbb{1}$ since these composed lifts fix the basepoints. Thus \widetilde{p}_1 and \widetilde{p}_2 are inverse isomorphisms.

The last statement follows immediately using Lemma 1.45. \square

It remains to discuss the question of whether there exist covering spaces of a given path-connected, locally path-connected space X realizing all subgroups of $\pi_1(X, x_0)$. There is a special case that is easily dealt with, that X is the orbit space \tilde{X}/G for a covering space action of a group G on a simply-connected space \tilde{X} . From Theorem 1.34 we know that G is isomorphic to $\pi_1(X, x_0)$ by the map sending $g \in G$ to the image in \tilde{X}/G of a path in \tilde{X} from the basepoint \tilde{x}_0 to $g(\tilde{x}_0)$. A subgroup of $\pi_1(X, x_0)$ corresponds to a subgroup H of G , and the covering space $\tilde{X} \rightarrow \tilde{X}/G$ factors as the composition of two maps $\tilde{X} \xrightarrow{a} \tilde{X}/H \xrightarrow{p} \tilde{X}/G$, each of which is obviously a covering space. We have $\pi_1(\tilde{X}/H, q(\tilde{x}_0)) \approx H$, and in fact $\Gamma(\tilde{X}/H, q(\tilde{x}_0))$ is the subgroup of $\pi_1(X, x_0)$ corresponding to H under the isomorphism $G \approx \pi_1(X, x_0)$ since a loop in X at x_0 lifts to a loop in \tilde{X}/H at $q(\tilde{x}_0)$ iff its lift to \tilde{X} starting at \tilde{x}_0 ends at a point $h(\tilde{x}_0)$ for some $h \in H$. Thus we obtain all possible path-connected covering spaces of \tilde{X}/G , up to isomorphism, as orbit spaces \tilde{X}/H for subgroups $H \subset G$.

Our strategy for general X will be to show that this special case is really the general case. The easier part will be to show that if X has a simply-connected covering space \tilde{X} then there is a covering space action of $\pi_1(X, x_0)$ on \tilde{X} with orbit space just X itself.

For an arbitrary covering space $p: \tilde{X} \rightarrow X$ one can consider the isomorphisms from this covering space to itself. These are called **deck transformations** or **covering transformations**. They form a group $G(\tilde{X})$ under composition. For example, for the covering space $\mathbb{R} \rightarrow S^1$ projecting a vertical helix onto a circle, the deck transformations are the vertical translations taking the helix onto itself, so $G(\tilde{X}) \approx \mathbb{Z}$ in this case.

Lemma 1.49. *For a covering space $p: \tilde{X} \rightarrow X$ with X and \tilde{X} path-connected and locally path-connected, the action of $G(\tilde{X})$ on \tilde{X} is a covering space action.*

Proof: By local path-connectedness, each point in X has a path-connected open neighborhood U such that $p^{-1}(U)$ is a disjoint union of copies of U projecting homeomorphically to U by p , so these are the path-components of $p^{-1}(U)$. Any deck transformation just permutes these path-components. The result now follows from the fact that the action of $G(\tilde{X})$ is free, since a deck transformation of a path-connected covering space is uniquely determined by where it sends a point, by the unique lifting property. \square

Now let us specialize the lemma to the case that \tilde{X} is simply-connected. By the lifting criterion there exists a deck transformation taking the basepoint \tilde{x}_0 to any other point in $p^{-1}(x_0)$. This means that the orbit space $\tilde{X}/G(\tilde{X})$ is just X , or more precisely that p induces a homeomorphism from $\tilde{X}/G(\tilde{X})$ onto X . In particular $G(\tilde{X})$ is isomorphic to $\pi_1(X, x_0)$.

Thus we have shown:

Proposition 1.50. *If a path-connected, locally path-connected space X has a simply-connected covering space, then every subgroup of $\pi_1(X, x_0)$ is realized as $\Gamma(\tilde{X}, \tilde{x}_0)$ for some covering space $(\tilde{X}, \tilde{x}_0) \rightarrow (X, x_0)$. \square*

A consequence of the preceding constructions is that a simply-connected covering space of a path-connected, locally path-connected space X is a covering space of every other path-connected covering space of X . This justifies calling a simply-connected covering space of X a **universal cover**. It is unique up to isomorphism, so one can in fact say *the* universal cover. More generally, there is a partial ordering on the various path-connected covering spaces of X , according to which ones cover which others. This corresponds to the partial ordering by inclusion of the corresponding subgroups of $\pi_1(X)$, or conjugacy classes of subgroups if basepoints are ignored.

There remains the question of when a space X has a simply-connected covering space. A necessary condition is the following: Each point $x \in X$ has a neighborhood U such that the inclusion-induced map $\pi_1(U, x) \rightarrow \pi_1(X, x)$ is trivial. One says X is **semilocally simply-connected** if this holds. To see the necessity of this condition, suppose $p: \tilde{X} \rightarrow X$ is a covering space with \tilde{X} simply-connected. Every point $x \in X$ has a neighborhood U having a lift $\tilde{U} \subset \tilde{X}$ projecting homeomorphically to U by p . Each loop in U lifts to a loop in \tilde{U} , and the lifted loop is nullhomotopic in \tilde{X} since $\pi_1(\tilde{X}) = 0$. So, composing this nullhomotopy with p , the original loop in U is nullhomotopic in X .

A locally simply-connected space is certainly semilocally simply-connected. For example, CW complexes have the much stronger property of being locally contractible, as we show in the Appendix. An example of a space that is not semilocally simply-connected is the shrinking wedge of circles, the subspace $X \subset \mathbb{R}^2$ consisting of the circles of radius $1/n$ centered at the point $(1/n, 0)$ for $n = 1, 2, \dots$, introduced in Example 1.25. On the other hand, the cone $CX = (X \times I)/(X \times \{0\})$ is semilocally simply-connected since it is contractible, but it is not locally simply-connected.

Proposition 1.51. *A space that is path-connected and locally path-connected has a simply-connected covering space iff it is semilocally simply-connected.*

Proof: It remains to prove the ‘if’ implication. To motivate the construction, suppose $p: (\tilde{X}, \tilde{x}_0) \rightarrow (X, x_0)$ is a simply-connected covering space. Each point $\tilde{x} \in \tilde{X}$ can then be joined to \tilde{x}_0 by a unique homotopy class of paths, by Proposition 1.6, so we can view points of \tilde{X} as homotopy classes of paths starting at \tilde{x}_0 . The advantage of this is that, by the homotopy lifting property, homotopy classes of paths in \tilde{X} starting at \tilde{x}_0 are the same as homotopy classes of paths in X starting at x_0 . This gives a way of describing \tilde{X} purely in terms of X .

Given a path-connected, locally path-connected, semilocally simply-connected space X with a basepoint $x_0 \in X$, we are therefore led to define

$$\tilde{X} = \{ [y] \mid y \text{ is a path in } X \text{ starting at } x_0 \}$$

where, as usual, $[\gamma]$ denotes the homotopy class of γ with respect to homotopies that fix the endpoints $\gamma(0)$ and $\gamma(1)$. The function $p: \tilde{X} \rightarrow X$ sending $[\gamma]$ to $\gamma(1)$ is then well-defined. Since X is path-connected, the endpoint $\gamma(1)$ can be any point of X , so p is surjective.

Before we define a topology on \tilde{X} we make a few preliminary observations. Let \mathcal{U} be the collection of path-connected open sets $U \subset X$ such that $\pi_1(U) \rightarrow \pi_1(X)$ is trivial. Note that if the map $\pi_1(U) \rightarrow \pi_1(X)$ is trivial for one choice of basepoint in U , it is trivial for all choices of basepoint since U is path-connected. A path-connected open subset $V \subset U \in \mathcal{U}$ is also in \mathcal{U} since the composition $\pi_1(V) \rightarrow \pi_1(U) \rightarrow \pi_1(X)$ will also be trivial. It follows that \mathcal{U} is a basis for the topology on X if X is locally path-connected and semilocally simply-connected.

Given a set $U \in \mathcal{U}$ and a path γ in X from x_0 to a point in U , let

$$U_{[\gamma]} = \{ [\gamma \cdot \eta] \mid \eta \text{ is a path in } U \text{ with } \eta(0) = \gamma(1) \}$$

As the notation indicates, $U_{[\gamma]}$ depends only on the homotopy class $[\gamma]$. Observe that $p: U_{[\gamma]} \rightarrow U$ is surjective since U is path-connected and injective since different choices of η joining $\gamma(1)$ to a fixed $x \in U$ are all homotopic in X , the map $\pi_1(U) \rightarrow \pi_1(X)$ being trivial. Another property is

$U_{[\gamma]} = U_{[\gamma']}$ if $[\gamma'] \in U_{[\gamma]}$. For if $\gamma' = \gamma \cdot \eta$ then elements of $U_{[\gamma']}$ have the form $[\gamma \cdot \eta \cdot \mu]$ and hence lie in $U_{[\gamma]}$, while elements of $U_{[\gamma]}$ have the form $[\gamma \cdot \mu] = [\gamma \cdot \eta \cdot \bar{\eta} \cdot \mu] = [\gamma' \cdot \bar{\eta} \cdot \mu]$ and hence lie in $U_{[\gamma']}$.

This can be used to show that the sets $U_{[\gamma]}$ form a basis for a topology on \tilde{X} . For if we are given two such sets $U_{[\gamma]}$, $V_{[\gamma']}$ and an element $[\gamma''] \in U_{[\gamma]} \cap V_{[\gamma']}$, we have $U_{[\gamma]} = U_{[\gamma']}$ and $V_{[\gamma']} = V_{[\gamma']}$ by (*). So if $W \in \mathcal{U}$ is contained in $U \cap V$ and contains $\gamma''(1)$ then $W_{[\gamma'']} \subset U_{[\gamma'']} \cap V_{[\gamma'']}$ and $[\gamma''] \in W_{[\gamma'']}$.

The bijection $p: U_{[\gamma]} \rightarrow U$ is a homeomorphism since it gives a bijection between the subsets $V_{[\gamma']}$ $\subset U_{[\gamma]}$ and the sets $V \in \mathcal{U}$ contained in U . Namely, in one direction we have $p(V_{[\gamma']}) = V$ and in the other direction we have $p^{-1}(V) \cap U_{[\gamma]} = V_{[\gamma']}$ for any $[\gamma'] \in U_{[\gamma]}$ with endpoint in V , since $V_{[\gamma']} \subset U_{[\gamma']} = U_{[\gamma]}$ and $V_{[\gamma']}$ maps onto V by the bijection p .

The preceding paragraph implies that $p: \tilde{X} \rightarrow X$ is continuous. We can also deduce that this is a covering space since for fixed $U \in \mathcal{U}$, the sets $U_{[\gamma]}$ for varying $[\gamma]$ partition $p^{-1}(U)$ because if $[\gamma''] \in U_{[\gamma]} \cap U_{[\gamma']}$ then $U_{[\gamma]} = U_{[\gamma']} = U_{[\gamma']}$ by (*).

It remains only to show that \tilde{X} is simply-connected. For a point $[\gamma] \in \tilde{X}$ let γ_t be the path in X obtained by restricting γ to the interval $[0, t]$. Then the function $t \mapsto [\gamma_t]$ is a path in \tilde{X} lifting γ that starts at $[x_0]$, the homotopy class of the constant path at x_0 , and ends at $[\gamma]$. Since $[\gamma]$ was an arbitrary point in \tilde{X} , this shows that \tilde{X} is path-connected. To show that $\pi_1(\tilde{X}, [x_0]) = 0$ it suffices to show that the image of this group under p_* is trivial since p_* is injective. Elements in the image of p_* are represented by loops γ at x_0 that lift to loops in \tilde{X} at $[x_0]$. We have observed that

the path $t \mapsto [y_t]$ lifts y starting at $[x_0]$, and for this lifted path to be a loop means that $[y_1] = [x_0]$. Since $y_1 = y$, this says that $[y] = [x_0]$, so y is nullhomotopic and the image of p_* is trivial. \square

A covering space $p: \tilde{X} \rightarrow X$ is called **normal** if for each $x \in X$ and each pair of points \tilde{x}, \tilde{x}' in $p^{-1}(x)$ there is a deck transformation taking \tilde{x} to \tilde{x}' . Intuitively, a normal covering space is one with maximal symmetry. This can be seen in the covering spaces of $S^1 \vee S^1$ shown in the table earlier in this section, where the normal covering spaces are (1), (2), (5)-(8), and (11). Note that in (7) the group of deck transformations is \mathbb{Z}_4 while in (8) it is $\mathbb{Z}_2 \times \mathbb{Z}_2$.

Sometimes normal covering spaces are called regular covering spaces. The term 'normal' is motivated by the following result.

Proposition 1.52. *Let $p: (\tilde{X}, \tilde{x}_0) \rightarrow (X, x_0)$ be a path-connected covering space of the path-connected, locally path-connected space X , and let H be the subgroup $p_*(\pi_1(\tilde{X}, \tilde{x}_0)) \subset \pi_1(X, x_0)$. Then:*

- (a) *This covering space is normal iff H is a normal subgroup of $\pi_1(X, x_0)$.*
- (b) *$G(\tilde{X})$ is isomorphic to the quotient $N(H)/H$ where $N(H)$ is the normalizer of H in $\pi_1(X, x_0)$.*

In particular, $G(\tilde{X})$ is isomorphic to $\pi_1(X, x_0)/H$ if \tilde{X} is a normal covering.

Proof: Recall Lemma 1.45, which says that for a loop y in X at x_0 representing a class $g \in \pi_1(X, x_0)$ and lifting to a path \tilde{y} starting at \tilde{x}_0 and ending at a point $\tilde{x}_1 \in p^{-1}(x_0)$, then $\Gamma(\tilde{X}, \tilde{x}_0) = g\Gamma(\tilde{X}, \tilde{x}_1)g^{-1}$, or equivalently $\Gamma(\tilde{X}, \tilde{x}_1) = g^{-1}\Gamma(\tilde{X}, \tilde{x}_0)g$. Hence g is in the normalizer $N(H)$ iff $\Gamma(\tilde{X}, \tilde{x}_0) = \Gamma(\tilde{X}, \tilde{x}_1)$. By the lifting criterion this is equivalent to the existence of a deck transformation taking \tilde{x}_0 to \tilde{x}_1 . Hence the covering space is normal iff $N(H) = \pi_1(X, x_0)$, that is, iff H is a normal subgroup of $\pi_1(X, x_0)$.

Define $\varphi: N(H) \rightarrow G(\tilde{X})$ sending g to the deck transformation τ taking \tilde{x}_0 to \tilde{x}_1 , in the notation above. To see that φ is a homomorphism, let g' be another element of $N(H)$ corresponding to a deck transformation τ' taking \tilde{x}_0 to the basepoint \tilde{x}'_1 at the end of the path \tilde{y}' in \tilde{X} starting at \tilde{x}_0 and lifting a loop y' representing g' . Then $y \cdot y'$ lifts to $\tilde{y} \cdot (\tau(\tilde{y}'))$, a path that goes from \tilde{x}_0 first to $\tilde{x}_1 = \tau(\tilde{x}_0)$ and then to $\tau(\tilde{x}'_1) = \tau\tau'(\tilde{x}_0)$, so $\tau\tau'$ is the deck transformation corresponding to gg' , which says that $\varphi(gg') = \tau\tau'$. Surjectivity of φ follows from the argument in the preceding paragraph since for $\tau \in G(\tilde{X})$ we can let g be the element of $\pi_1(X, x_0)$ represented by the projection of a path in \tilde{X} from \tilde{x}_0 to $\tau(\tilde{x}_0)$, and then $\varphi(g) = \tau$. The kernel of φ consists of those elements $g \in \pi_1(X, x_0)$ represented by loops y whose lifts to \tilde{X} starting at \tilde{x}_0 are loops. Thus the kernel of φ is H , so φ induces an isomorphism $N(H)/H \approx G(\tilde{X})$. \square

Representing Covering Spaces by Permutations

We wish to describe now another way of classifying the different covering spaces of a connected, locally path-connected, semilocally simply-connected space X , without restricting just to connected covering spaces. To give the idea, consider the 3-sheeted covering spaces of S^1 . There are three of these, \tilde{X}_1 , \tilde{X}_2 , and \tilde{X}_3 , with the subscript indicating the number of components. For each of these covering spaces $p: \tilde{X}_i \rightarrow S^1$ the three different lifts of a loop in S^1 generating $\pi_1(S^1, x_0)$ determine a permutation of $p^{-1}(x_0)$ sending the starting point of the lift to the ending point of the lift. For \tilde{X}_1 this is a cyclic permutation, for \tilde{X}_2 it is a transposition of two points fixing the third point, and for \tilde{X}_3 it is the identity permutation. These permutations obviously determine the covering spaces uniquely, up to isomorphism. The same would be true for n -sheeted covering spaces of S^1 for arbitrary n , even for n infinite.

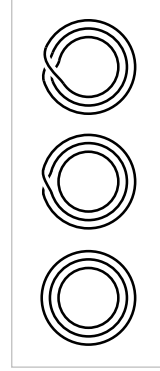

The covering spaces of $S^1 \vee S^1$ can be encoded using the same idea. Referring back to the large table of examples near the beginning of this section, we see in the covering space (1) that the loop a lifts to the identity permutation of the two vertices and b lifts to the permutation that transposes the two vertices. In (2), both a and b lift to transpositions of the two vertices. In (3) and (4), a and b lift to transpositions of different pairs of the three vertices, while in (5) and (6) they lift to cyclic permutations of the vertices. In (11) the vertices can be labeled by \mathbb{Z} , with a lifting to the identity permutation and b lifting to the shift $n \mapsto n + 1$. Indeed, one can see from these examples that a covering space of $S^1 \vee S^1$ is nothing more than an efficient graphical representation of a pair of permutations of a given set.

This idea of lifting loops to permutations generalizes to arbitrary covering spaces. For a covering space $p: \tilde{X} \rightarrow X$, a path γ in X has a unique lift $\tilde{\gamma}$ starting at a given point of $p^{-1}(\gamma(0))$, so we obtain a well-defined map $L_\gamma: p^{-1}(\gamma(0)) \rightarrow p^{-1}(\gamma(1))$ by sending the starting point $\tilde{\gamma}(0)$ of each lift $\tilde{\gamma}$ to its ending point $\tilde{\gamma}(1)$. It is evident that L_γ is a bijection since $L_{\bar{\gamma}}$ is its inverse. For a composition of paths $\gamma\eta$ we have $L_{\gamma\eta} = L_\eta L_\gamma$, rather than $L_\gamma L_\eta$, since composition of paths is written from left to right while composition of functions is written from right to left. To compensate for this, let us modify the definition by replacing L_γ by its inverse. Thus the new L_γ is a bijection $p^{-1}(\gamma(1)) \rightarrow p^{-1}(\gamma(0))$, and $L_{\gamma\eta} = L_\gamma L_\eta$. Since L_γ depends only on the homotopy class of γ , this means that if we restrict attention to loops at a basepoint $x_0 \in X$, then the association $\gamma \mapsto L_\gamma$ gives a homomorphism from $\pi_1(X, x_0)$ to the group of permutations of $p^{-1}(x_0)$. This is called *the action of $\pi_1(X, x_0)$ on the fiber $p^{-1}(x_0)$* .

Let us see how the covering space $p: \tilde{X} \rightarrow X$ can be reconstructed from the associated action of $\pi_1(X, x_0)$ on the fiber $F = p^{-1}(x_0)$, assuming that X is connected, path-connected, and semilocally simply-connected, so it has a universal cover $\tilde{X}_0 \rightarrow X$.

We can take the points of \tilde{X}_0 to be homotopy classes of paths in X starting at x_0 , as in the general construction of a universal cover. Define a map $h: \tilde{X}_0 \times F \rightarrow \tilde{X}$ sending a pair $([y], \tilde{x}_0)$ to $\tilde{y}(1)$ where \tilde{y} is the lift of y to \tilde{X} starting at \tilde{x}_0 . Then h is continuous, and in fact a local homeomorphism, since a neighborhood of $([y], \tilde{x}_0)$ in $\tilde{X}_0 \times F$ consists of the pairs $([y\eta], \tilde{x}_0)$ with η a path in a suitable neighborhood of $y(1)$. It is obvious that h is surjective since X is path-connected. If h were injective as well, it would be a homeomorphism, which is unlikely since \tilde{X} is probably not homeomorphic to $\tilde{X}_0 \times F$. Even if h is not injective, it will induce a homeomorphism from some quotient space of $\tilde{X}_0 \times F$ onto \tilde{X} . To see what this quotient space is, suppose $h([y], \tilde{x}_0) = h([y'], \tilde{x}'_0)$. Then y and y' are both paths from x_0 to the same endpoint, and from the figure we see that $\tilde{x}'_0 = L_{y'\bar{y}}(\tilde{x}_0)$. Letting λ be the loop $y'\bar{y}$, this means that $h([y], \tilde{x}_0) = h([\lambda y], L_\lambda(\tilde{x}_0))$. Conversely, for any loop λ we have $h([y], \tilde{x}_0) = h([\lambda y], L_\lambda(\tilde{x}_0))$. Thus h induces a well-defined map to \tilde{X} from the quotient space of $\tilde{X}_0 \times F$ obtained by identifying $([y], \tilde{x}_0)$ with $([\lambda y], L_\lambda(\tilde{x}_0))$ for each $[\lambda] \in \pi_1(X, x_0)$. Let this quotient space be denoted \tilde{X}_ρ where ρ is the homomorphism from $\pi_1(X, x_0)$ to the permutation group of F specified by the action.

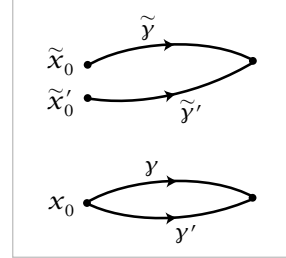

Notice that the definition of \tilde{X}_ρ makes sense whenever we are given an action ρ of $\pi_1(X, x_0)$ on a set F . There is a natural projection $\tilde{X}_\rho \rightarrow X$ sending $([y], \tilde{x}_0)$ to $y(1)$, and this is a covering space since if $U \subset X$ is an open set over which the universal cover \tilde{X}_0 is a product $U \times \pi_1(X, x_0)$, then the identifications defining \tilde{X}_ρ simply collapse $U \times \pi_1(X, x_0) \times F$ to $U \times F$.

Returning to our given covering space $\tilde{X} \rightarrow X$ with associated action ρ , the map $\tilde{X}_\rho \rightarrow \tilde{X}$ induced by h is a bijection and therefore a homeomorphism since h was a local homeomorphism. Since this homeomorphism $\tilde{X}_\rho \rightarrow \tilde{X}$ takes each fiber of \tilde{X}_ρ to the corresponding fiber of \tilde{X} , it is an isomorphism of covering spaces.

If two covering spaces $p_1: \tilde{X}_1 \rightarrow X$ and $p_2: \tilde{X}_2 \rightarrow X$ are isomorphic, one may ask how the corresponding actions of $\pi_1(X, x_0)$ on the fibers F_1 and F_2 over x_0 are related. An isomorphism $h: \tilde{X}_1 \rightarrow \tilde{X}_2$ restricts to a bijection $F_1 \rightarrow F_2$, and evidently $L_y(h(\tilde{x}_0)) = h(L_y(\tilde{x}_0))$. Using the less cumbersome notation $y\tilde{x}_0$ for $L_y(\tilde{x}_0)$, this relation can be written more concisely as $yh(\tilde{x}_0) = h(y\tilde{x}_0)$. A bijection $F_1 \rightarrow F_2$ with this property is what one would naturally call an *isomorphism of sets with $\pi_1(X, x_0)$ action*. Thus isomorphic covering spaces have isomorphic actions on fibers. The converse is also true, and easy to prove. One just observes that for isomorphic actions ρ_1 and ρ_2 , an isomorphism $h: F_1 \rightarrow F_2$ induces a map $\tilde{X}_{\rho_1} \rightarrow \tilde{X}_{\rho_2}$ and h^{-1} induces a similar map in the opposite direction, such that the compositions of these two maps, in either order, are the identity.

This shows that n -sheeted covering spaces of X are classified by equivalence classes of homomorphisms $\pi_1(X, x_0) \rightarrow \Sigma_n$, where Σ_n is the symmetric group on n

symbols and the equivalence relation identifies a homomorphism ρ with each of its conjugates $h^{-1}\rho h$ by elements $h \in \Sigma_n$. The study of the various homomorphisms from a given group to Σ_n is a very classical topic in group theory, so we see that this algebraic question has a nice geometric interpretation.

Exercises

1. For a covering space $p: \tilde{X} \rightarrow X$ and a subspace $A \subset X$, let $\tilde{A} = p^{-1}(A)$. Show that the restriction $p: \tilde{A} \rightarrow A$ is a covering space.
2. Show that if $p_1: \tilde{X}_1 \rightarrow X_1$ and $p_2: \tilde{X}_2 \rightarrow X_2$ are covering spaces, so is their product $p_1 \times p_2: \tilde{X}_1 \times \tilde{X}_2 \rightarrow X_1 \times X_2$.
3. Let $p: \tilde{X} \rightarrow X$ be a covering space with $p^{-1}(x)$ finite and nonempty for all $x \in X$. Show that \tilde{X} is compact Hausdorff iff X is compact Hausdorff.
4. Construct a simply-connected covering space of the space $X \subset \mathbb{R}^3$ that is the union of a sphere and a diameter. Do the same when X is the union of a sphere and a circle intersecting it in two points.
5. Let X be the subspace of \mathbb{R}^2 consisting of the four sides of the square $[0, 1] \times [0, 1]$ together with the segments of the vertical lines $x = 1/2, 1/3, 1/4, \dots$ inside the square. Show that for every covering space $\tilde{X} \rightarrow X$ there is some neighborhood of the left edge of X that lifts homeomorphically to \tilde{X} . Deduce that X has no simply-connected covering space.
6. Let X be the shrinking wedge of circles in Example 1.25, and let \tilde{X} be its covering space shown in the figure below.

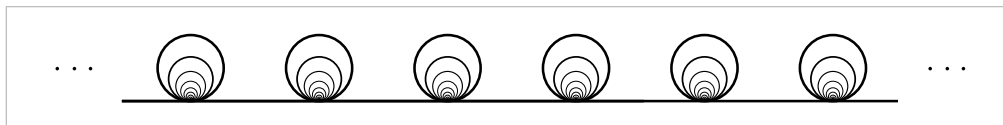

Construct a two-sheeted covering space $Y \rightarrow \tilde{X}$ such that the composition $Y \rightarrow \tilde{X} \rightarrow X$ of the two covering spaces is not a covering space. Note that a composition of two covering spaces does have the unique path lifting property, however.

7. Let Y be the *quasi-circle* shown in the figure, a closed subspace of \mathbb{R}^2 consisting of a portion of the graph of $y = \sin(1/x)$, the segment $[-1, 1]$ in the y -axis, and an arc connecting these two pieces. Collapsing the segment of Y in the y -axis to a point gives a quotient map $f: Y \rightarrow S^1$. Show that f does not lift to the covering space $\mathbb{R} \rightarrow S^1$, even though $\pi_1(Y) = 0$. Thus local path-connectedness of Y is a necessary hypothesis in the lifting criterion.

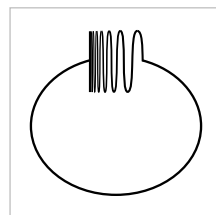

8. Let \tilde{X} and \tilde{Y} be simply-connected covering spaces of the path-connected, locally path-connected spaces X and Y . Show that if $X \simeq Y$ then $\tilde{X} \simeq \tilde{Y}$. [Exercise 10 in Chapter 0 may be helpful.]

9. Show that if a path-connected, locally path-connected space X has $\pi_1(X)$ finite, then every map $X \rightarrow S^1$ is nullhomotopic. [Use the covering space $\mathbb{R} \rightarrow S^1$.]
10. Find all the connected 2-sheeted and 3-sheeted covering spaces of $S^1 \vee S^1$, up to isomorphism.
11. Construct finite graphs X_1 and X_2 having a common finite-sheeted covering space $\tilde{X}_1 = \tilde{X}_2$, but such that there is no space having both X_1 and X_2 as covering spaces.
12. Let a and b be the generators of $\pi_1(S^1 \vee S^1)$ corresponding to the two S^1 summands. Draw a picture of the covering space of $S^1 \vee S^1$ corresponding to the normal subgroup generated by a^2 , b^2 , and $(ab)^4$, and prove that this covering space is indeed the correct one.
13. Determine the covering space of $S^1 \vee S^1$ corresponding to the subgroup of $\pi_1(S^1 \vee S^1)$ generated by the cubes of all elements. The covering space is 27-sheeted and can be drawn on a torus so that the complementary regions are nine triangles with edges labeled aaa , nine triangles with edges labeled bbb , and nine hexagons with edges labeled $ababab$. [For the analogous problem with sixth powers instead of cubes, the resulting covering space would have $2^{28}3^{25}$ sheets! And for k^{th} powers with k sufficiently large, the covering space would have infinitely many sheets. The underlying group theory question here, whether the quotient of $\mathbb{Z} * \mathbb{Z}$ obtained by factoring out all k^{th} powers is finite, is known as Burnside's problem. It can also be asked for a free group on n generators.]
14. Find all the connected covering spaces of $\mathbb{R}P^2 \vee \mathbb{R}P^2$, up to isomorphism.
15. Let $p: \tilde{X} \rightarrow X$ be a simply-connected covering space of X and let $A \subset X$ be a path-connected, locally path-connected subspace, with $\tilde{A} \subset \tilde{X}$ a path-component of $p^{-1}(A)$. Show that $p: \tilde{A} \rightarrow A$ is the covering space corresponding to the kernel of the map $\pi_1(A) \rightarrow \pi_1(X)$.
16. Given maps $X \rightarrow Y \rightarrow Z$ such that both $Y \rightarrow Z$ and the composition $X \rightarrow Z$ are covering spaces, show that $X \rightarrow Y$ is a covering space if Z is locally path-connected, and show that this covering space is normal if $X \rightarrow Z$ is a normal covering space.
17. Given a group G and a normal subgroup N , show that there exists a normal covering space $\tilde{X} \rightarrow X$ with $\pi_1(X) \approx G$, $\pi_1(\tilde{X}) \approx N$, and deck transformation group $G(\tilde{X}) \approx G/N$.
18. For a path-connected, locally path-connected, and semilocally simply-connected space X , call a path-connected covering space $\tilde{X} \rightarrow X$ *abelian* if it is normal and has abelian deck transformation group. Show that X has an abelian covering space that is a covering space of every other abelian covering space of X , and that such a 'universal' abelian covering space is unique up to isomorphism. Describe this covering space explicitly for $X = S^1 \vee S^1$ and $X = S^1 \vee S^1 \vee S^1$.
19. Use the preceding problem to show that a closed orientable surface M_g of genus g has a connected normal covering space with deck transformation group isomorphic

to \mathbb{Z}^n (the product of n copies of \mathbb{Z}) iff $n \leq 2g$. For $n = 3$ and $g \geq 3$, describe such a covering space explicitly as a subspace of \mathbb{R}^3 with translations of \mathbb{R}^3 as deck transformations. Show that such a covering space in \mathbb{R}^3 exists iff there is an embedding of M_g in the 3-torus $T^3 = S^1 \times S^1 \times S^1$ such that the induced map $\pi_1(M_g) \rightarrow \pi_1(T^3)$ is surjective.

20. Construct nonnormal covering spaces of the Klein bottle by a Klein bottle and by a torus. [Look for nonnormal subgroups of the group of deck transformations of the universal cover.]

21. Let X be the space obtained from a torus $S^1 \times S^1$ by attaching a Möbius band via a homeomorphism from the boundary circle of the Möbius band to the circle $S^1 \times \{x_0\}$ in the torus. Compute $\pi_1(X)$, describe the universal cover of X , and describe the action of $\pi_1(X)$ on the universal cover. Do the same for the space Y obtained by attaching a Möbius band to $\mathbb{R}P^2$ via a homeomorphism from its boundary circle to the circle in $\mathbb{R}P^2$ formed by the 1-skeleton of the usual CW structure on $\mathbb{R}P^2$.

22. Given covering space actions of groups G_1 on X_1 and G_2 on X_2 , show that the action of $G_1 \times G_2$ on $X_1 \times X_2$ defined by $(g_1, g_2)(x_1, x_2) = (g_1(x_1), g_2(x_2))$ is a covering space action, and that $(X_1 \times X_2)/(G_1 \times G_2)$ is homeomorphic to $X_1/G_1 \times X_2/G_2$.

23. Show that if a group G acts freely and properly discontinuously on a Hausdorff space X , then the action is a covering space action. (Here ‘properly discontinuously’ means that each $x \in X$ has a neighborhood U such that $\{g \in G \mid U \cap g(U) \neq \emptyset\}$ is finite.) In particular, a free action of a finite group on a Hausdorff space is a covering space action.

24. Given a covering space action of a group G on a path-connected, locally path-connected space X , then each subgroup $H \subset G$ determines a composition of covering spaces $X \rightarrow X/H \rightarrow X/G$. Show:

- Every path-connected covering space between X and X/G is isomorphic to X/H for some subgroup $H \subset G$.
- Two such covering spaces X/H_1 and X/H_2 of X/G are isomorphic iff H_1 and H_2 are conjugate subgroups of G .
- The covering space $X/H \rightarrow X/G$ is normal iff H is a normal subgroup of G , in which case the group of deck transformations of this cover is G/H .

25. Let $\varphi: \mathbb{R}^2 \rightarrow \mathbb{R}^2$ be the linear transformation $\varphi(x, y) = (2x, y/2)$. This generates an action of \mathbb{Z} on $X = \mathbb{R}^2 - \{0\}$. Show this action is a covering space action and compute $\pi_1(X/\mathbb{Z})$. Show the orbit space X/\mathbb{Z} is non-Hausdorff, and describe how it is a union of four subspaces homeomorphic to $S^1 \times \mathbb{R}$, coming from the complementary components of the x -axis and the y -axis.

26. For a covering space $p: \tilde{X} \rightarrow X$ with X connected, locally path-connected, and semilocally simply-connected, show:

- (a) The components of \tilde{X} are in one-to-one correspondence with the orbits of the action of $\pi_1(X, x_0)$ on the fiber $p^{-1}(x_0)$.
- (b) Under the Galois correspondence between connected covering spaces of X and subgroups of $\pi_1(X, x_0)$, the subgroup corresponding to the component of \tilde{X} containing a given lift \tilde{x}_0 of x_0 is the *stabilizer* of \tilde{x}_0 , the subgroup consisting of elements whose action on the fiber leaves \tilde{x}_0 fixed.
27. For a universal cover $p: \tilde{X} \rightarrow X$ we have two actions of $\pi_1(X, x_0)$ on the fiber $p^{-1}(x_0)$, namely the action given by lifting loops at x_0 and the action given by restricting deck transformations to the fiber. Are these two actions the same when $X = S^1 \vee S^1$ or $X = S^1 \times S^1$? Do the actions always agree when $\pi_1(X, x_0)$ is abelian?
28. [This has become Theorem 1.34.]
29. Let Y be path-connected, locally path-connected, and simply-connected, and let G_1 and G_2 be subgroups of $\text{Homeo}(Y)$ defining covering space actions on Y . Show that the orbit spaces Y/G_1 and Y/G_2 are homeomorphic iff G_1 and G_2 are conjugate subgroups of $\text{Homeo}(Y)$.
30. Draw the Cayley graph of the group $\mathbb{Z} * \mathbb{Z}_2 = \langle a, b \mid b^2 \rangle$.
31. Show that the normal covering spaces of $S^1 \vee S^1$ are precisely the graphs that are Cayley graphs of groups with two generators. More generally, the normal covering spaces of the wedge sum of n circles are the Cayley graphs of groups with n generators.
32. Consider covering spaces $p: \tilde{X} \rightarrow X$ with \tilde{X} and X connected CW complexes, the cells of \tilde{X} projecting homeomorphically onto cells of X . Restricting p to the 1-skeleton then gives a covering space $\tilde{X}^1 \rightarrow X^1$ over the 1-skeleton of X . Show:
- (a) Two such covering spaces $\tilde{X}_1 \rightarrow X$ and $\tilde{X}_2 \rightarrow X$ are isomorphic iff the restrictions $\tilde{X}_1^1 \rightarrow X^1$ and $\tilde{X}_2^1 \rightarrow X^1$ are isomorphic.
- (b) $\tilde{X} \rightarrow X$ is a normal covering space iff $\tilde{X}^1 \rightarrow X^1$ is normal.
- (c) The groups of deck transformations of the coverings $\tilde{X} \rightarrow X$ and $\tilde{X}^1 \rightarrow X^1$ are isomorphic, via the restriction map.
33. In Example 1.42 let d be the greatest common divisor of m and n , and let $m' = m/d$ and $n' = n/d$. Show that the graph $T_{m,n}/K$ consists of m' vertices labeled a , n' vertices labeled b , together with d edges joining each a vertex to each b vertex. Deduce that the subgroup $K \subset G_{m,n}$ is free on $dm'n' - m' - n' + 1$ generators.